

# EMPIRE<sup>®</sup> PROPHECY<sup>™</sup>

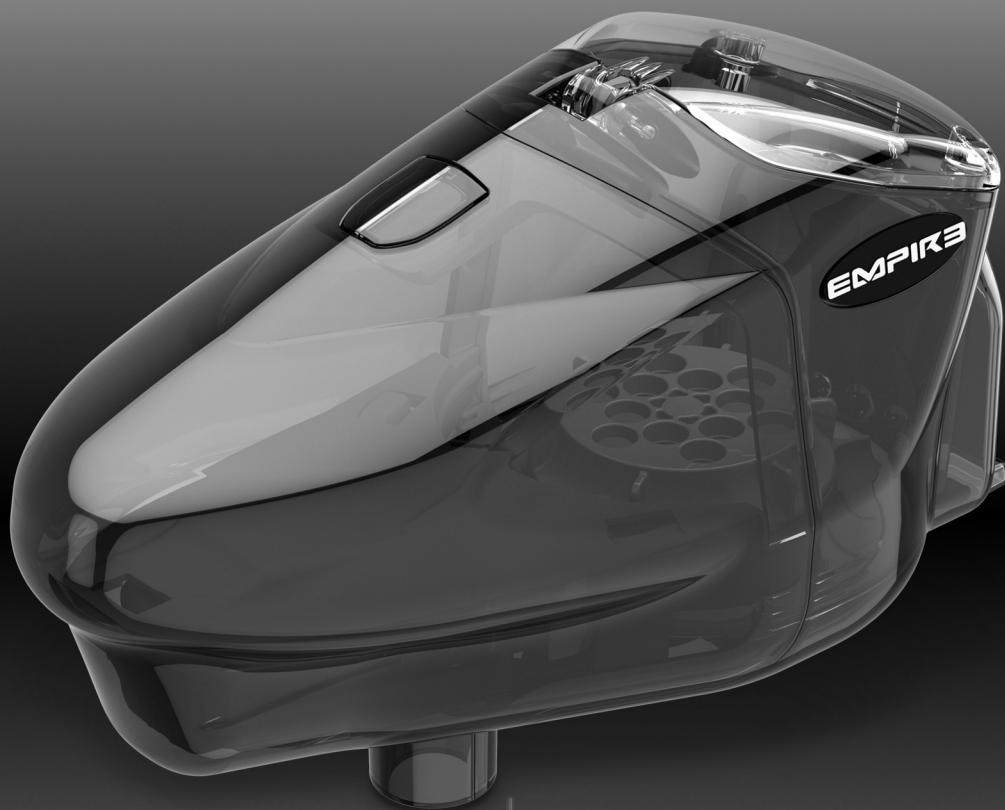

**OPERATION MANUAL**

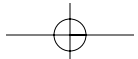
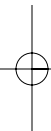
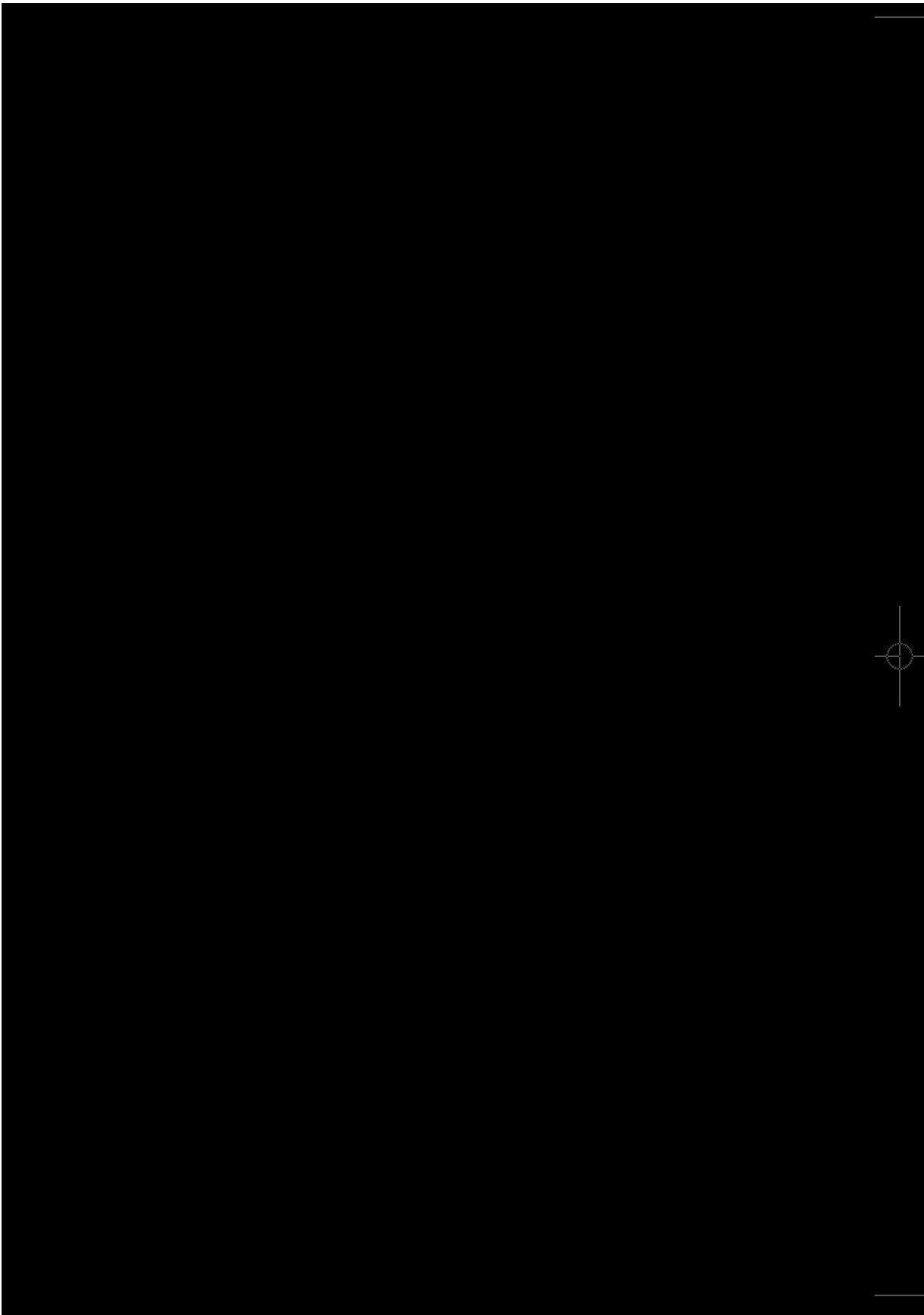
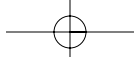

# Prophecy™ Loader

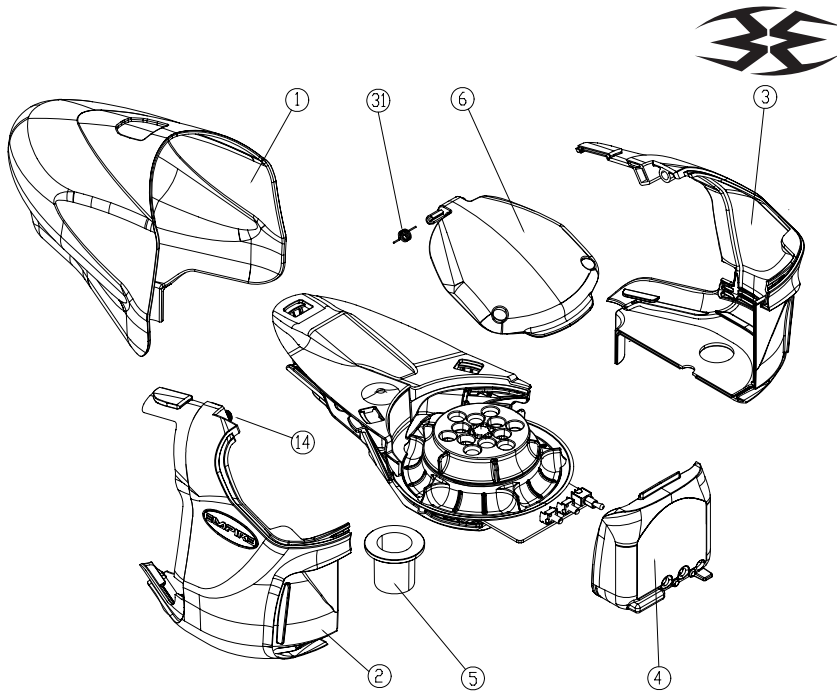

Prophecy™ Loader

## WARNING PAINTBALL GUNS AND PAINTBALL GUN ACCESSORIES ARE NOT TOYS

- Careless use or misuse may result in serious bodily injury or death!
- Eye protection designed for paintball must be worn by the user and all persons within range.
- Not for sale to persons under 18 years of age.
- Must be 18 years of age or older to operate or handle any paintball gun and paintball gun accessories without adult of parental supervision.
- Read and understand all cautions, warnings, and operating manuals before using any paintball gun or paintball gun accessory.
- Do not aim paintball gun at eyes or head of people or at animals.
- Paintball guns are to be used with .68 caliber Paintballs Only
- To prevent fire or shock hazard, do not expose unit to rain or moisture.
- To prevent fire or shock hazard, do not immerse unit in liquids.
- To prevent fire or shock hazard, do not disassemble any electronic paintball device.
- The disposal of the battery used to power this product may be regulated in your area. Please conform to all local or state regulations with regard to battery disposal.
- Use Common Sense and have fun.

Any tampering with the unit voids your warranty. The use of non factory authorized components within this product may cause a fire or shock hazard and will void your warranty. IN NO EVENT SHALL SELLER BE LIABLE FOR ANY DIRECT, INCIDENTAL OR CONSEQUENTIAL DAMAGES OF ANY NATURE, OR LOSSES OR EXPENSES RESULTING FROM ANY DEFECTIVE PRODUCT OR THE USE OF ANY PRODUCT.

**EMPIRE**  
PAINTBALL SYSTEM  
PAINTBALL LOADER

# Contents



## Table of Contents

<b>INTRODUCTION</b>	<b>4</b>
<ul style="list-style-type: none"><li>• General Description</li><li>• Included Items</li><li>• Specifications</li><li>• Features</li><li>• Accessories</li></ul>	
<b>GETTING STARTED</b>	<b>7</b>
<ul style="list-style-type: none"><li>• Battery Installation</li><li>• Attaching the Loader</li><li>• Powering the Loader</li><li>• Advancing the Ball Stack</li><li>• Turning off the Loader</li></ul>	
<b>SETTING UP</b>	<b>9</b>
<ul style="list-style-type: none"><li>• Using the Loader in Sound Mode</li><li>• Using the Loader in RF (radio frequency) Mode</li><li>• Synchronizing the Loader to your Marker</li></ul>	
<b>GENERAL CARE</b>	<b>11</b>
<ul style="list-style-type: none"><li>• Emptying the Loader for Storage</li><li>• Cleaning the Loader</li></ul>	
<b>BASIC OPERATIONS</b>	<b>12</b>
<ul style="list-style-type: none"><li>• Adjusting Clutch Drive Force</li><li>• Rip Drive™</li></ul>	

# Contents



## Table of Contents

<b>BOARD FUNCTIONS</b>	<b>14</b>
<ul style="list-style-type: none"> <li>• Programming</li> <li>• Adjusting Settings</li> </ul>	
<b>MARKER RF (RADIO FREQUENCY) TRANSMITTER</b>	<b>17</b>
<ul style="list-style-type: none"> <li>• Installing the RF Harness</li> <li>• Attaching the RF Transmitter</li> <li>• Testing the RF System</li> </ul>	
<b>DISASSEMBLY</b>	<b>18</b>
<ul style="list-style-type: none"> <li>• Body Disassembly</li> <li>• Drive Disassembly</li> </ul>	
<b>LOADER ASSEMBLY</b>	<b>22</b>
<ul style="list-style-type: none"> <li>• Lower Drive Assembly</li> <li>• Upper Drive Assembly</li> <li>• Body Assembly</li> </ul>	
<b>DIAGRAMS</b>	<b>31</b>
<b>PARTS LIST</b>	<b>34</b>
<b>TROUBLE SHOOTING GUIDE</b>	<b>35</b>
<b>EMPIRE PROPHECY WARRANTY &amp; REGISTRATION</b>	<b>36</b>

PAT. NOS. 5,791,325; 5,947,100; 6,109,252; 6,792,933; GB2322438, other Patents Pending.  
© All Rights Reserved.

**EMPIRE<sup>®</sup> PROPHECY<sup>™</sup>**  
PAINTBALL LOADER SYSTEM

# Introduction



## Introduction

### INTRODUCTION

Congratulations on your purchase of the Empire Prophecy Paintball Loader System with Halo Technology. The Empire Prophecy is the future of loader technology realized today. Precisely crafted with a blend of traditional styling and new ultra advanced technology and features, the Empire Prophecy is the revelation of loader technology.

**NO TOOLS REQUIRED!** That's right, no tools...period. You no longer need any tools to work on your loader, change the battery, disassemble to clean, swap out lids, etc. – just utilize the intuitive snap and lock technology and you are good to go.

Easy to use electronic functionality and the all new quick change clutch set up (no loader disassembly required!), along with the integrated freeway anti-jam and multiple speed settings, result in the Empire Prophecy being the fastest, gentlest on paint, easiest to use, and the most advanced loader in the long, successful history of the HALO Technology legacy.

#### Included Items

- Loader
- Manual
- Spare Parts Kit

#### Specifications

- Model- Prophecy
- Standard Power Source- (4) AA batteries
- Capacity- approximately 240 balls

#### Features

##### Mechanical Points

- Quick change front bodies. No tools required. Different capacity front bodies approximately 200, 240 (standard) and 280.
- Light weight, one piece front body section for increased strength at the most commonly impacted area.
- Quick change batteries. No tools required.
- Quick change lids. No tools required. Standard Magnetic Lid.
- Quick change back plates. No tools required. (Allows for changing graphics or software and allows interface updates on aftermarket boards).
- Easy software updating (front of board with standard loader after removing body front).
- Quick disassembly/assembly - no tools required to disassembly body system down to the main drive - **NO NUTS BOLTS OR SCREWS ANYWHERE IN LOADER.**

# Introduction



## Features Continued Mechanical Points

- Quick change clutch settings. No tools required. No disassembly of the loader required. Drive cone extension can be removed through the lid opening and re-configured quickly and easily.
- Delrin drive carrier and extension as stock.
- Fully ball raced drive carrier.
- Ultra large feed opening.
- Advanced drive system with preload drive carrier extension - aids consistency and auto clears jams.
- Magnet force loading. **NO SPRING TO PRE-WIND.** Fast and consistent. Adjustable via magnet configuration.
- Integrated freeway anti-jam and anti-blowback venting.
- Interchangeable “snap in/snap out” one piece feed neck.
- Ultra light design. Lighter than any other Halo style loader.
- Takes standard rip drive wheels.
- Reversing ramp - lifts balls up and out of the drive to prevent jams and broken paint on back up.
- Ready for easy upgrades to aftermarket circuit boards and software.
- Spring and/or magnet lid opening system.
- Easy assembly modular “back bone” drive system.

# Introduction



## Introduction

### Features Electronics Points

- Toggle switch on/off.
- Sound Activation.
- RF Activation - Compatible with Magna Drive RF Transmitter link system, Hater VICI Platform.
- Motor sensing.
- Anti-popcorning technology.
- 4 - AA's or 2 - 9 volt operation.
- Easy software updates.
- 6 sound settings
- 6 speed/torque settings
- One way locking wiring harness connectors.
- High torque motor.

### Accessories

- Front body sections in 200 and 280+ configuration.
- Friction fit lid
- Quick load lid.
- Two 9 volt adapter
- Look for upcoming product upgrades at [EmpirePaintball.com](http://EmpirePaintball.com).



# Getting Started



## GETTING STARTED

### Battery Installation

There are no tools needed to install the batteries into the Prophecy Loader. Remove the body front by pressing in the lower spring lock and the upper tab, and then slide the body front forward.



Getting Started

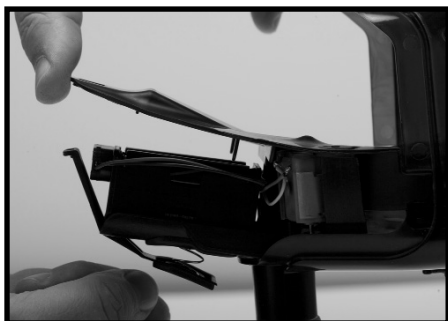

- Push in the front tab on the floor and gently lift the front of the floor.
- Remove the battery pack and install batteries into the pack following the polarity markings. Install the battery pack back into the backbone; lock the pack in place by pushing the front tab arm in and lowering the floor. Then reinstall the body front by sliding it back on.

#### Notes:

- For best results, only use quality brand batteries. When replacing batteries, used batteries should be recycled.
- Make sure the batteries are installed correctly, pay attention to the (+/-) polarity markings.

**EMPIRE**  
PAINTBALL LOADER SYSTEM

# Getting Started



## Getting Started

### Attaching the Loader

You can attach your Prophecy Loader to the markers feedneck or you may need an elbow to attach it properly. The Prophecy Loader is designed to fit in standard clamping style feednecks.

Simply place the Prophecy Loader into your markers feedneck, adjust the clamp adjustment screw, and push the clamp closed. If the clamp shows too much resistance when trying to close, loosen the feed neck's adjustment screw. If it's too loose, tighten the feed neck's adjustment screw, until the loader is secure.

#### Notes:

You want to hold the loader securely but be careful not to crush or damage the feedneck. **Do not over tighten the feedneck.**

### Powering the Loader

Flip the toggle switch to the left, which is the on position. When you first flip the switch the motor will spin and a flashing green LED will appear. The loader will have a green flashing LED when on. When an RF signal is received, the LED will change to a flashing blue when on.

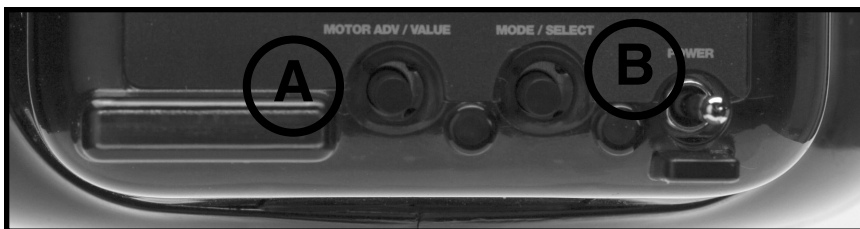

### Advancing the Ball Stack

You can advance the ball stack by pressing button (A). Each time the button is pressed the drive will spin and a red LED will flash. This is useful after you refill your loader to make sure the ball stack is full and tensioned.

Do not hold button (A) in, just quickly push and release the button. Holding the button in will make the loader enter RF sync mode.

### Turning Off the Loader

Flip the toggle switch to the right, which is the off position; the loader is now off. If the loader is left on, it will shut off after 1 hour of inactivity.

# Setting Up



## SETTING UP

## Setting Up

### Using the Loader in Sound Mode

The Prophecy Loader is defaulted to Sound Activation. Simply turn the Prophecy Loader on and check that the loader is being activated by the sound of your marker. If necessary you can adjust the sound sensitivity level to match your markers sound signature. See the Board Function section for more details on changing the sensitivity.

It is recommended that you lock the Prophecy Loader into Sound Activation if you are not using RF Activation. This will prevent any RF signals from activating your loader. See the Board Functions section for instructions.

If RF Activation is being used you can switch back to Sound Mode by pushing button (A) one time and the LED will change from a flashing blue to flashing green LED. If button (A) is pushed 3 times after the loader is turned on it will lock into sound mode until the loader is turned off.

### Using the Loader in RF Mode

To use the Loader in RF mode, an Empire RF Transmitter must be installed in your marker or you must use a compatible Hater™ RF board. Read the section "Marker RF Transmitter" for installation instructions.

RF Activation will allow you to use RF and Sound Activation. RF Activation will not work if you change the Activation setting to sound.

With the RF Activation turned on, the Prophecy Loader will automatically switch to RF when a signal is received from your marker. If no signal is received the loader will activate with sound. The Prophecy Loader will automatically switch to RF once a signal is received.

- When the loader is in RF Mode the loader will spin every 5 seconds to keep tension on the ball stack.
- If you encounter RF signal issues, you can change and lock into Sound Activation by pressing button (A) three times.



# Setting Up



## Setting Up

### Synchronizing Loader to your Marker

It is recommended that you synchronize your loader to your marker for optimal performance when using RF Mode. Also, synchronizing your loader will prevent other RF signals from interfering with your signal. It is possible to synchronize two markers with Empire RF Transmitters to your Prophecy Loader.

- 1) Make sure your marker is degassed and unloaded.
- 2) Turn your marker on with the eyes turned off. Read your markers manual for eye operation if you are having problems turning them off.
- 3) Turn on the Prophecy Loader.
- 4) Press button (A) and hold in until the solid red LED turns to orange.
- 5) Release button (A) and while the orange LED is lit, pull the trigger on your marker. This must be done within 2 seconds of the LED changing to orange.
- 6) If done correctly the LED will change from orange to green if a signal is received from your marker.

You are now ready to use your Prophecy Loader in RF Mode.

# General Care



## GENERAL CARE

## General Care

### Emptying the Loader for Storage

With the loader turned off, turn it upside down to dump the paintballs out. While upside down, rotate the Rip Drive counter clockwise to release the paintballs. Do not store your Prophecy Loader with any paintballs remaining inside.

When storing the loader for an extended period of time, remove the battery pack completely and store in a dry place where it will not come in contact with the loader itself or any metal parts.

### Cleaning Loader

To clean the loader, use a clean dry cloth, or apply a small amount of water or goggle lens cleaner to a clean cloth. Apply only enough water or cleaner to dampen the cloth. Do not apply goggle lens cleaner directly to loader surfaces, as too much contact may deteriorate the plastic.

If any paintballs break inside the loader, Do Not use any Liquids or Chemicals to rinse out the loader, doing so may cause severe damage to the loader electronics.

In most cases you will be able to clean the drive area of the loader by just removing the body front and wiping it out using a damp towel. If it is necessary to further clean the loader, follow the disassembly instructions.



# Basic Operations



## Basic Operations

### BASIC OPERATIONS

#### Adjusting Clutch Drive Force

- 1) Remove the drive carrier extension, by lifting it off the clutch shaft. If the drive carrier extension is difficult to remove, wiggle it from side to side while pulling upwards.

You can do this with a fully assembled loader, by removing it through the lid opening. If you find it difficult to remove it through the lip opening, remove the body front for easier access to the carrier extension.

- 2) On the drive carrier extension there are (12) locations for magnets.

The spots for the magnets toward the center of the drive carrier extension will supply a constant force to the drive carrier. The spots on the outside of the drive carrier extension will supply an intermittent force to the drive carrier when the clutch slips. Too many magnets may prevent the clutch from slipping at all, while too few magnets will prevent the drive carrier from properly feeding paintballs.

The picture to the right is the default configuration; which is well suited for most types of paintballs:

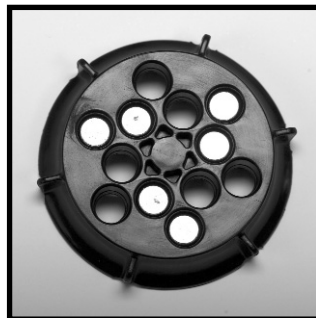

The picture to the left is an example of a good initial configuration for tournament paintballs:

# Basic Operations



- 3) To change the location or quantity of the magnets, push the magnets out of the drive carrier extension from the bottom and then reinstall them with their polarity facing the same direction. Stack the magnets together to identify the positive (+) and negative (-) sides of the magnets and install them with the same polarity facing in one direction.
- 4) After you have setup your drive carrier extension. Place the drive carrier extension on top of the clutch shaft and rotate it until it lines up with the flats on the clutch shaft and gently push down on the drive carrier extension.

#### Note:

If you are having issues setting up the drive carrier extension magnets, it is recommend that you return it to the default configuration.

### Rip Drive

The Rip Drive is the thumbwheel located under the Prophecy Loader.

#### It has several uses:

- 1) Manually pre-tension up to 8 paintballs into your paintball gun for every revolution of the thumbwheel. This can be done to chronograph your gun without the need to turn on the loader, or to feed paintballs if your batteries should happen to die during a game.
- 2) Clear a ball jam in your loader during a game by rotating the rip drive counter clockwise and clearing the jam, then forwards again to pre-tension the ball stack.
- 3) Load balls into your marker if your batteries go dead.
- 4) Remove tension from the ball stack between games.

# Board Functions



## Board Functions

### BOARD FUNCTIONS

#### Programming

There are 4 functions which can be adjusted in Programming Mode. The default settings should be good for most markers and types of game play.

**Motor Speed** - 6 levels of adjustment, level (1) being the slowest motor speed and level (6) being the fastest.

Note:

- It is recommended that you do not set the speed higher than needed; using higher speeds than needed will shorten the life of your batteries.
- Using too fast of a motor speed can actually lower the rate of fire of your marker, as the clutch will always be slipping and the magnets will be unable to create enough feeding force.

**Sound Sensitivity** - 6 levels of adjustment, level (1) being the least sensitive and level (6) being the most sensitive.

Note:

It is better to have the microphone setting less sensitive and still able to detect the marker firing. Do not set it to 6 if setting 2 detects the marker firing correctly. Only use a higher setting if the lower setting does not detect the marker firing.

**Ball Stack Tension Monitoring** - There are two settings: (1) Off and (2) On. This feature monitors the ball stack tension. This helps prevent ball breaks from overpowering the drive carrier. Also this feature determines when the drive carrier is empty and the motor speed is slowed down to help prevent ball breakage when the loader is very close to being empty.

Enabling this feature will increase the battery life and reduce ball breaks but may slightly reduce the top speed of the loader.



# Board Functions



Board Functions

**Activation Mode-** There are two settings: (1) Sound Activation only and (2) RF and Sound Activation.

	Functions	LED Color	Default Value	Range
1	Motor Speed	Solid Green	3	1 - 6
2	Sound Sensitivity	Solid Orange	3	1 - 6
3	Stack Monitoring	Solid Red	2	1 - 2
4	Activation Mode	Solid Blue	2	1 - 2

## Entering Programming Mode

On the back plate of the Prophecy Loader there are two buttons which are used to adjust the loaders functions. Button (A) is used to enter a new value for the selected function. Button (B) is used to enter into programming mode and to cycle thru the different functions.

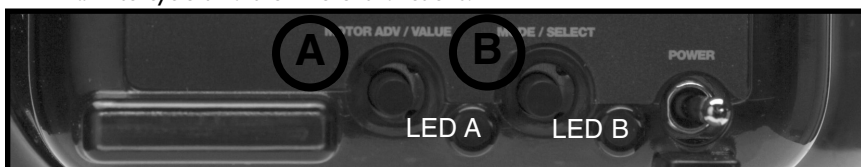

**Entering Programming Mode-** Turn the loader on, then push and hold in button (B), until a rapidly flashing green LED appears, then release the button and it will go to solid green. You are now in programming mode.

If at any time in programming mode, there is 10 seconds of inactivity, the loader will automatically exit programming mode.

## Adjusting Settings

**Cycling thru Functions-** Once you have entered the programming mode, use button (B) to cycle thru the four functions. If the yellow LED is flashing a functions current value, you can skip to the next function by pushing button (B) for one second. If the yellow LED is not flashing a current value, you only have to push button (B) quickly to go to the next function.

**Changing a Functions Value-** Select the function you wish to change, watch the yellow LED for the functions current value. Once the yellow LED stops flashing; enter your new value, by pushing button (A) the appropriate amount of times (see chart above). After entering the new value, wait about 3 seconds and the yellow LED will flash the new value you entered will be set.



# Board Functions



## Board Functions

### Exiting Programming Mode

Once you are done changing the settings, there are three ways to exit programming mode.

- You can wait 10 seconds and the loader will exit programming mode automatically.
- Turn the loader off with the toggle switch.
- Push in button (B) for 2 seconds, a solid green LED will appear, and then release the button.

### Example- Locking Loader into Sound Activation:

- 1) Turn loader on and enter programming mode by holding in button (B) until a flashing green LED appears. It is recommended you do this if you do not have an RF transmitter your gun.
- 2) Press Button (B) three times (holding-button for approximately one second each time) and a blue LED will appear. Once the blue LED appears the yellow LED will flash its current value (2 Flashes).
- 3) Press button (A) one time to enter the new value and wait for the yellow LED to show the new value, which will be one flash for Sound Activation only.
- 4) Exit Programming Mode by pushing and holding button (B) until solid green LED.

# Marker RF Transmitter



## MARKER RF TRANSMITTER (not included)

To use the Prophecy Loader in the RF Mode, you must install the Empire RF Transmitter in your marker or you must use a compatible Hater™ RF board. Use the harness that corresponds to your marker if available. If a harness for your marker is not available, it will be necessary to solder or connect the RF Transmitter to your marker's solenoid harness. Some newer markers and after market boards might have a connector already installed on the circuit board for the RF Transmitter.

### Installing RF Harness

The RF Harness needs to be installed to a RF Port on your markers circuit board or inline with your markers solenoid. The RF Transmitter Kit comes with three different harnesses that fit most markers. If none of the supplied harnesses fit your marker, it will be necessary to solder or modify the harness to go inline with your marker's solenoid. If you do not feel comfortable soldering or modifying you marker's harness, we recommend you get it installed by a certified paintball technician.

**Warning: Any damage or problems caused by soldering or modifying your marker are not covered under warranty.**

### Attaching RF Transmitter

The RF Transmitter simply plugs into the white harness with a 3 socket connector on the end. It does not matter which way it is plugged in. Try to place the transmitter as high in the frame as possible and gently bend the antenna, so it's facing toward the loader.

#### Note:

It is important that you place the transmitter in a safe location within your marker's grip frame. If it is going to be in contact with metal or your marker's circuit board, it is recommended you wrap the RF Transmitter in electrical tape. Do not tape over the transmitter's antenna or LEDs.

### Testing the RF

- 1) Make sure your marker is degassed and unloaded.
- 2) Place your Prophecy Loader onto your marker and lock down the feed neck.
- 3) Turn on your marker with eyes turned off.
- 4) Synchronize your loader to your marker (follow instructions in the Setting Up section) if needed.

# Disassembly



## Disassembly

### RF TRANSMITTER CONTINUED...

- 5) Turn on your loader and pull the trigger on your marker. The LED on your loader will change from green to blue if it receives a signal from your marker. If the LED does not change to blue, check that your loader is in RF activation mode.
- 6) Each time you pull the trigger the LED on the loader will flash blue and the loader will spin.

#### Note:

If your loader is not receiving a RF signal from your marker: see the troubleshooting section.

## DISASSEMBLY

### Body Disassembly

The body of the Prophecy Loader can be disassembled with no tools. Changing batteries and basic cleaning can be performed by removing the body front. It is recommended you do not remove the body sides unless you need to access the drive assembly.

**Body Front** - Press in the lower spring lock and the upper tab, and then simply slide the body front forward and off the drive assembly.

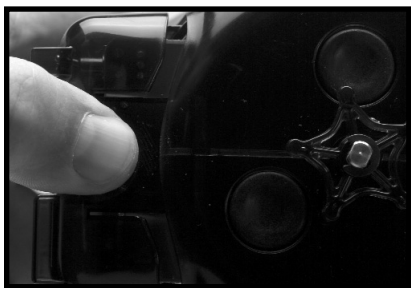

**Rear Cover** - Press in the tab located on the bottom of the rear cover and rotate the bottom of the cover away from the body. Once the bottom of the cover is away from the body, slightly lower the cover to release the upper locking tab and then remove.

**Lid** - The lid can be removed once the body front has been removed. Open the lid and hold it against the left side body, then gently push the right side body away from the lid. Tilt the lid to left and remove from the body. It only needs to be separated by a 1/4" inch to remove the lid. The body sides do not have to be removed from the drive assembly to remove the lid.

**Lid Spring** - The lid spring can be removed with the lid. Using it will help spring the lid open for fast loading. The lid is also held open by magnets, if you find you don't need the lid spring, you can remove it.

# Disassembly



## Disassembly



**Neck Insert** - The neck insert can be removed while the body sides are together, by snapping it out. Use your thumb to press the front spring tab down and out of the way of the neck insert. Then insert your fore-finger into the neck insert and pull it toward the front of the loader.

**Body Sides** - Press in each of the two spring locks located on the bottom of each body side and gently remove them from the drive assembly. If only one side is to be removed for cleaning, remove the right body side.

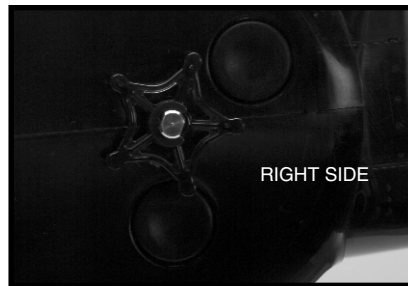

### Drive Disassembly

The drive assembly should only be taken apart for cleaning or repair. Remove the shell assembly first and follow the instruction below if it is necessary to work on the drive assembly.

**Floor** - Flex in the front backbone arm and lift the front of the floor from the drive assembly, then flex in both rear backbone arms with your thumb and forefinger at the same time and lift floor from the drive assembly.

**Outlet Cover** - Locate the alignment tab on the right side of the outlet cover and gently pull it up and out of the slide. It might be necessary to tilt the outlet cover toward the motor to remove it as part of it locks under the motor.

# Disassembly



## Disassembly

**Drive Carrier Extension** - The drive carrier extension is removed by lifting it off the clutch shaft. You may need to wiggle it from side to side to lift it off, as it is held in place by magnetic force.

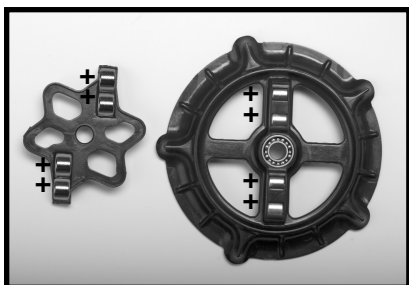

**Clutch Plate and Housing** - Remove the E-Ring from the clutch shaft that holds the clutch plate and the clutch housing in place. Lift the housing and plate off the clutch shaft. The drive carrier will most likely lift off the clutch shaft with the clutch housing.

**Note:**

- It is recommended that you keep the clutch plate housing and drive carrier together, to keep the correct positioning.
- Do not remove the magnets from the clutch plate housing. They are factory installed in a specific magnetic direction.

**Drive Carrier** - Once the clutch plate housing has been removed, the drive carrier will simply lift off the clutch shaft.

**Note:**

Do not remove the magnets from the drive cone. They are factory installed in a specific magnetic direction.

**Rip Drive** - The Rip Drive is removed by removing the E-Ring located on the bottom of the clutch shaft and pulling the rip drive off. If necessary use a flat head screwdriver to help lift the rip drive off the clutch shaft.

**Separating the Slide from the Backbone** - The slide is held to the backbone by three locking tabs (see picture), located on the top of the slide. Using a flat head screwdriver or coin gently pull the tabs one at a time toward the center of the slide until all three are released. Once all three locking tabs have been released the slide will lift off the backbone. It will also be necessary to unplug the motor harness from the circuit board.

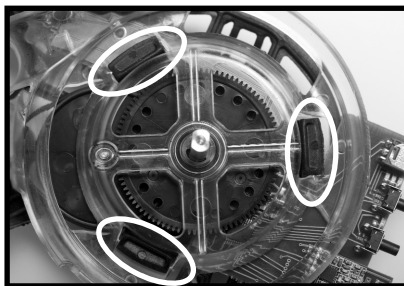

# Disassembly



Disassembly

**Note:**

When separating the slide from the backbone, the pulley, pulley pin and belt will be loose. Be careful not to lose any of these parts.

**Spring Locks and Springs** - The spring locks and lock springs should not be removed unless the springs or locks need replacing. The spring locks are removed by removing the spring first and then sliding the lock out.

**Circuit Board**- The circuit board can only be removed once the slide has been separated from the backbone. Gently flex the backbone arm that is closest to the board, to the right and lift the board off the front alignment post. While holding the backbone arm away from the board, rotate the board to the right to clear the slide locking tab. The board can now be removed from the backbone.

**Note:**

- Do not remove the circuit board unless it is necessary to replace it.
- Be very careful when removing or installing the circuit board. Do Not force the board!

# Loader Assembly



## Loader Assembly

### LOADER ASSEMBLY

#### Lower Drive Assembly

If the Lower Drive Assembly is not assembled correctly the Prophecy Loader will not function properly. It is recommended that you do not take the lower drive apart unless necessary.

#### Installing Circuit Board

- 1) Line up the rear post on the backbone with the rear hole on the board and gently lower the board onto the post.
- 2) Next lower the board onto the front post on the backbone. Gently pull back the front backbone tab, to lower the board into position. See Pictures below to check for proper positioning.

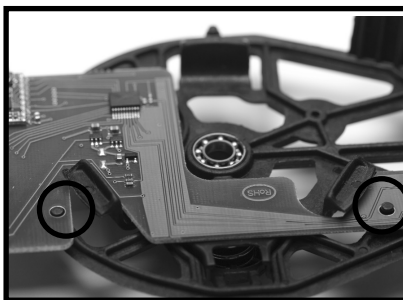

#### Installing the Sprocket to the Clutch Shaft

- 1) Slide the sprocket onto the clutch shaft with the sprockets flat side facing the E-Ring slot.
- 2) Put the E-Ring onto the clutch shaft to hold the sprocket in place.



# Loader Assembly



## Loader Assembly

### Installing the Lower Drive Components

- 1) Place the lower drive bearing into the bottom of the slide.
- 2) Insert the clutch shaft with sprocket attached into the slide. Make sure the flat side of the sprocket is facing the slide.
- 3) Place the pulley pin into the slide and slide the pulley onto it.
- 4) Install motor into the slide.
- 5) Put the drive belt onto the pulley and then stretch it onto the motor pulley.

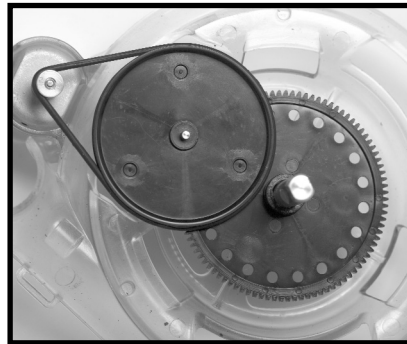

### Installing the Slide to the Backbone



- 1) Make sure the bearing is installed in the backbone.
- 2) Place the backbone with bearing facing the slide, onto the clutch shaft and position the slides feed neck toward the backbones feed hole.
- 3) Next you will have to lock the three backbone tabs onto the slide. Push the tabs into the backbone one at a time. It may be necessary to flip the drive assembly over while holding it together and use a quarter or flat head screwdriver to lock in the final tab.
- 4) Check that the pulley pin is seated in both the slide and backbone. If necessary gently push the pin using a small flat head screwdriver, so it correctly seats in both parts. Also check that the belt is properly positioned on the motor and pulley.  
(See correct alignment in following images)

# Loader Assembly



Loader Assembly

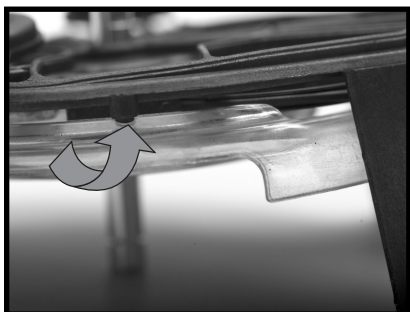

**CORRECT**



**INCORRECT**

## Installing Rip Drive

Place the rip drive wheel on the bottom of the clutch shaft and push it down until it stops. Install the E-Ring into the slot on the bottom of the clutch shaft.

## Testing the Lower Drive Assembly

Once the lower drive assembly is back together, rotate the rip drive wheel to check that it is rotating correctly. There should be some resistance from the belt but the clutch shaft should rotate smoothly.

## Upper Drive Assembly

If the drive assembly is not assembled correctly the Prophecy Loader will not function properly. The clutch plate housing and drive carrier extension must be installed with the correct magnet position to provide adequate force on the ball stack.

### Clutch Plate Housing and Drive Carrier Magnet Setup

It is recommended that you do not remove the magnets from either part as they are factory set in the correct position. If it is needed to reinstall the magnets, stack them together to identify the positive (+) and negative (-) sides of the magnets. Install the magnets as pictured below; make sure that on each part the magnets are all facing the same direction. Below is a picture which shows the correct placement of the magnets.

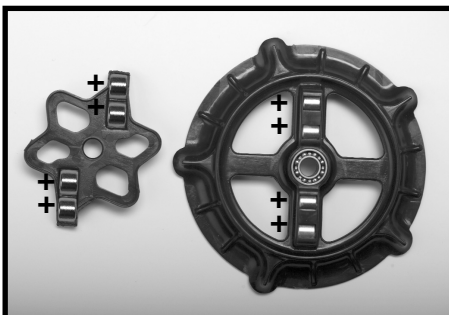

# Loader Assembly



## Loader Assembly

**Drive Carrier-** Make sure the drive carrier has 2 bearings and 4 magnets installed. Slide the drive carrier onto the clutch shaft and check that it spins freely. It is recommended that you very lightly oil the ball bearings, occasionally with 3 in 1 oil.

**Clutch Plate and Housing-** Place the clutch plate housing with the plate on the clutch shaft. Check that the drive carrier is correctly applying force toward the ball stack.

To check that drive carrier is setup correctly, hold the clutch plate housing still with one hand and then rotate the drive carrier clockwise with your other hand until it stops. Release the drive carrier while continuing to hold the clutch housing in place, the carrier should rotate counter clockwise under the magnet force. Do this several times to check proper function.

If it is not rotating correctly; lift up the clutch plate housing, rotate it 180 degrees while holding the drive carrier still and retest.

Once it is set correctly, install the E-Ring on to the clutch shaft to hold the clutch housing in position. Use a small flat head screw driver to carefully push the E-Ring onto the clutch shaft, just above the magnet plate. Be careful not to scratch the magnet plate when installing the E-Ring.



**Drive Carrier Extension-** If you look at the top of the clutch shaft, you will notice that two sides are flat. Place the drive carrier on top of the shaft and rotate it until it lines up with the flats on the clutch shaft. It will snap down into place under magnetic force once it lines up.

# Loader Assembly



## Loader Assembly



**Outlet Cover** - On the left side of the outlet cover you will notice two protruding parts. The one toward the front of the cover goes under the motor, and the other one goes into the feed area. Make sure these two parts of the cover are located properly before pushing the cover down into the right side alignment tab.



**Floor** - Place the floor over the backbone assembly, line up the center of the floor over the motor area of the slide. Flex in the backbone arms and lock them into the floor, one at a time, starting with the one on the left side, nearest to the motor. Check that the floor, outlet cover and slide fit flush with no gaps. Also check from the right side of the drive assembly that the outlet cover sits flush with the slide.

# Loader Assembly



## Loader Assembly



### Body Assembly

Assemble the body in the order listed below. The drive assembly must be completely assembled before assembling the body.

### Body Sides-

1) Install the right side shell first; making sure the slot on the inside of the body side is correctly over the drive assembly and that the body side is interlocked with the floor.

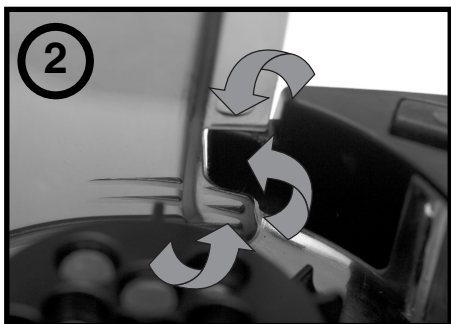

2) Next, attach the left side body shell to the drive assembly. As you're sliding the right side toward the left; lift the right side shell upward, making sure the slot on the inside of the body side is correctly over the drive assembly and that the body side is interlocked with the floor.

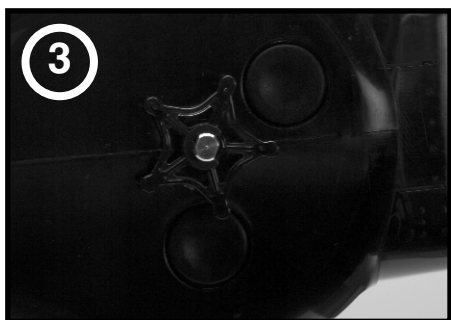

# Loader Assembly



## Loader Assembly



**CORRECT**

3) Make sure the tongue and groove of the body sides are interlocked and that both lower spring tabs are locked into the body sides.



**CORRECT**

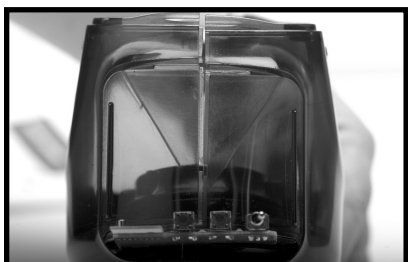

**INCORRECT**

# Loader Assembly



## Loader Assembly

**Lid with Spring-** You will notice one side of the spring is longer than the other. Install the spring onto the longer lid pivot arm (left side) and with the longer part of the spring toward the center of the lid. With the lid in the fully open position, insert the pivot arm with spring into the left side of the body. Align the right side of the body with the pivot arm, bring the two sides of the body together, and close the lid. Check that the body is aligned and that the lid opens and closes correctly.

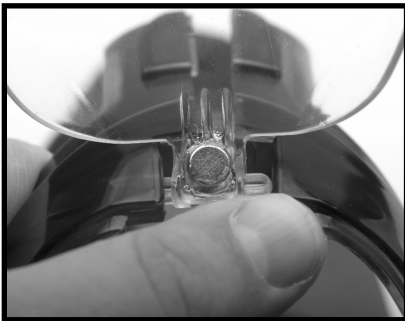
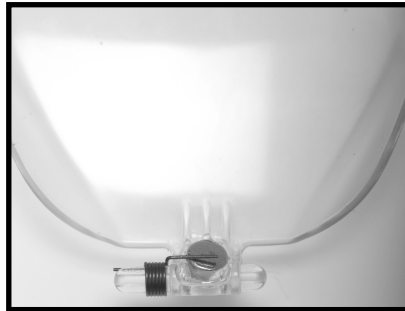

**Lid (no spring) -** Gently pull the two body sides apart a 1/4 inch and install the lid by inserting the longer pin in first.

**Neck Insert-** With the two body sides in place; slide the neck insert into the bodies feed neck. The neck insert should snap into place and then be secure.

**Rear Cover-** Put the top of the rear cover into the slot on the body, then gently rotate the cover down and lock the bottom tab into the body. Be careful not to damage the rear buttons on the circuit board.

**Body Front-** Slide the body front onto the drive assembly and push it until the upper tab and lower spring lock are in place. Be careful of the alignment and Do Not force it into place.



**EMPIRE<sup>®</sup>**  
PAINTBALL LOADER SYSTEM

# Diagrams



Diagrams

## DIAGRAM

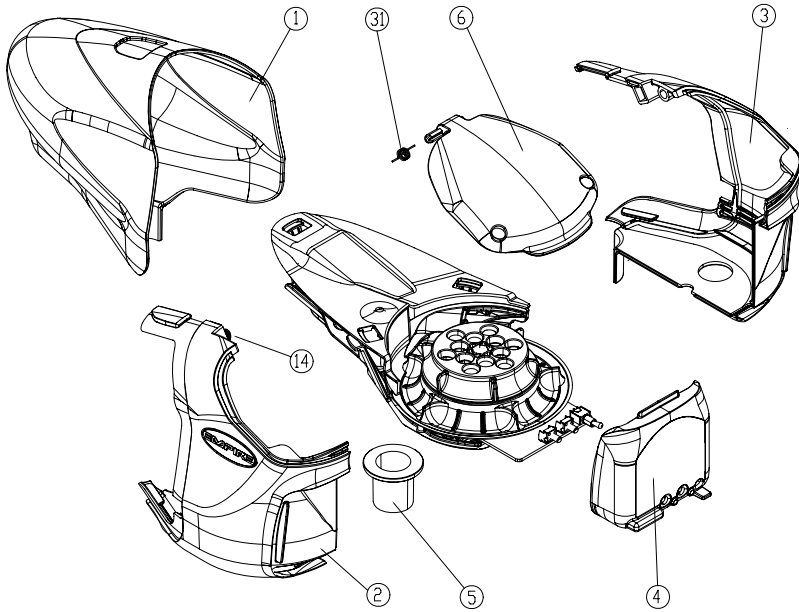



# Diagrams



## DIAGRAM

## Diagrams

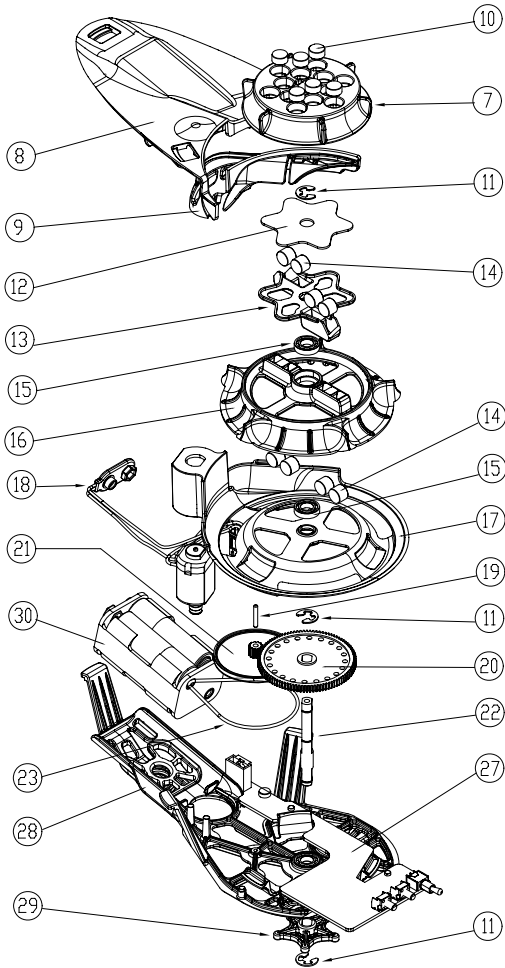

**EMPIRE'S**  
**EDGE**  
PAINTBALL LOADER SYSTEM

# Diagrams



Diagrams

## DIAGRAM

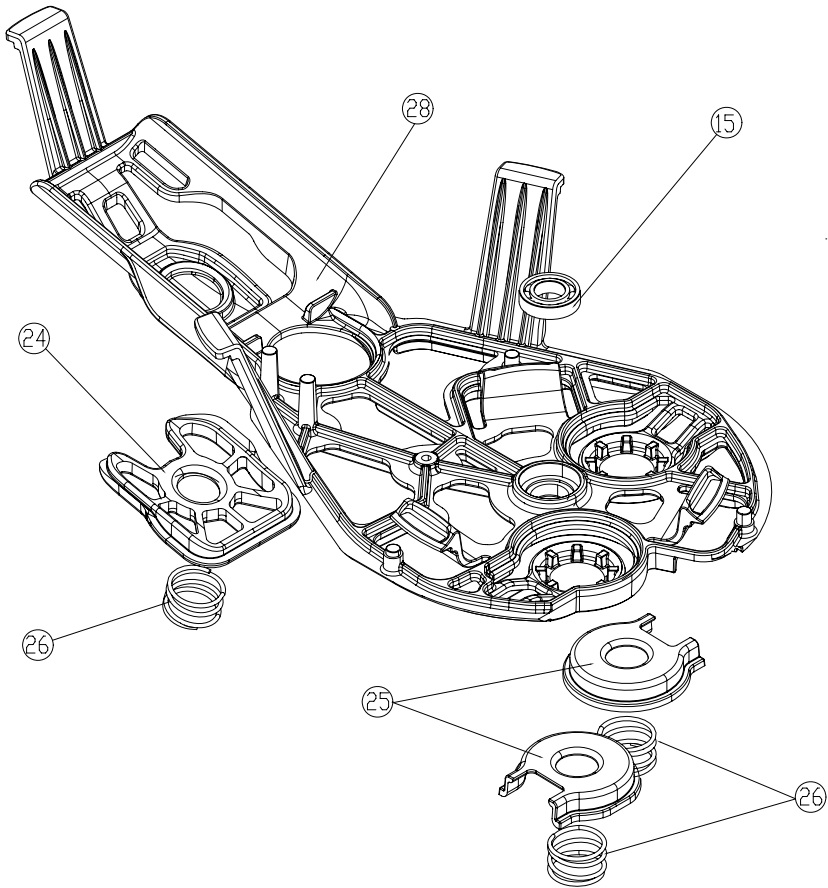

# Parts List



## PARTS LIST

## Parts List

DIAGRAM#	DESCRIPTION	PART#
1	Body Front	31000
2	Left Body Side (with magnets)	31001
3	Right Body Side (with magnets)	31002
4	Rear Cover	31003
5	Neck Insert	31004
6	Lid (with magnets)	31005
7	Drive Carrier Extension	31006
8	Floor	31007
9	Outlet Cover	31008
10	Magnet (8mm x 4mm)	31009
11	E-Ring (1/4 x .025 Thk)	38823
12	Magnet Plate (6-point)	31010
13	Clutch Plate Housing	31011
14	Magnet (8mm x 6mm)	38475
15	Bearing (R188)	38803
16	Drive Carrier	31012
17	Slide	31013
18	Moter with Harness	31024
19	Dowel Pin (0.78 Dia x .500)	38828
20	Sprocket	31014
21	Pulley	31015
22	Clutch Shaft	31016
23	Belt	31017
24	Spring Lock (front)	31018
25	Spring Lock (back)	31019
26	Lock Spring	31020
27	Backbone Circuit Board	31021
28	Back Bone	31022
29	RIP Drive 2 Wheel	31023
30	Battery Holder	38746
31	Lid Spring	38490

**EMPIRE**  
PAINTBALL LOADER SYSTEM

# Troubleshooting



## Trouble Shooting

### TROUBLESHOOTING GUIDE

Loader will not turn on	Batteries are low on power or installed incorrectly	Check the voltage of the batteries and make sure they follow the polarity markings on the battery pack
	Circuit board is not plugged in correctly	Remove the circuit board cover and check if its plugged in correctly
Loader is not feeding	Outlet cover installed incorrectly.	Check that the outlet cover is sitting in the slide correctly. Look in the feed neck and drive area to check alignment
	Drive cone top has too few magnets	Add magnets to the drive cone top or return it to the default setup
Loader is feeding inconsistently	Batteries are low	Check the voltage of the batteries with a multimeter
	Clutch plate housing is installed incorrectly	Rotate the clutch plate housing 180 degrees and retest.
	Too few magnets on the drive cone top	Install more drive cone top magnet or return the setup to default
Spring locks are not locking into body	Drive assembly is not sitting in body correctly	The drive assembly has to sit into the lower groove on the inside of the rear body sides
	Rear body sides are not lined up	Check if the tongue and groove of the rear body shells are interlocked
Lid is not staying closed or opened	Magnets not installed	Check that the lid magnet and body magnets are installed correctly
Drive cone is not tensioning the ball stack	Clutch plate housing installed incorrectly	Rotate the clutch plate housing 180 degrees and retest.
	Drive cone or clutch plate housing magnets installed incorrectly	If the magnets are installed wrong the drive cone will not tension the stack.
Magnets are coming lose	The magnets should be a tight press fit. Over time they maybe come lose	Make sure there in correctly and use super glue to hold magnets in place
Loader is not receiving a RF signal	Marker is not sending a signal or the signal is weak	Check the connections to the marker and check that the transmitter is receiving a signal
	Loader is locked into sound activation	Enter programming mode and check the current setting of the activation mode

# Notes



Notes

**EMPIRE<sup>®</sup>**  
**PROPHECY<sup>™</sup>**  
PAINTBALL LOADER SYSTEM

# Warranty / Registration



## WARRANTY REGISTRATION

Empire Paintball Products warranties this Prophecy™ paintball loader from defects in materials and workmanship under normal use and service for a period of 90 days from original purchase date. The manufacturer agrees to repair or replace any part which has been found to be defective. The outer shell is not covered under this warranty if it is broken due to misuse, dropped, or collided with another object. This product also has a limited extended warranty of one year from original purchase date covering the operation of the circuit board. Damage to the circuit board due to disassembly of the product is not covered under this warranty. In the event that this product is defective and needs repair call Paintball Solutions. If our customer service department asks for the loader to be sent in for repair; Place loader inside a box, along with your name, return address, daytime telephone number, a brief description of the problem, and a copy of your original sales receipt.

It is the responsibility of the purchaser to pay for shipping fees of the product to the repair facility during the warranty period.

Troubleshooting: If you experience any difficulties with operating this product and you have not found the solution in this manual, please call 800-220-3222, or visit on the internet at <http://www.paintballsolutions.com>.

**CUT HERE**



### SEND TO:

Paintball Solutions  
55 Howard Ave.  
Des Plains, IL 60018  
800-220-3222  
[www.paintballsolutions.com](http://www.paintballsolutions.com)

### PURCHASE INFORMATION:

Purchased From: \_\_\_\_\_  
City \_\_\_\_\_ State: \_\_\_\_\_ Zip: \_\_\_\_\_  
Serial \_\_\_\_\_

### OWNER INFORMATION:

Your Name \_\_\_\_\_  
City \_\_\_\_\_ State: \_\_\_\_\_ Zip: \_\_\_\_\_  
Phone \_\_\_\_\_ Email: \_\_\_\_\_

Warranty / Registration



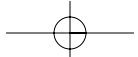
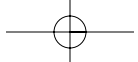

# EMPIRE<sup>®</sup> PROPHECY<sup>™</sup>

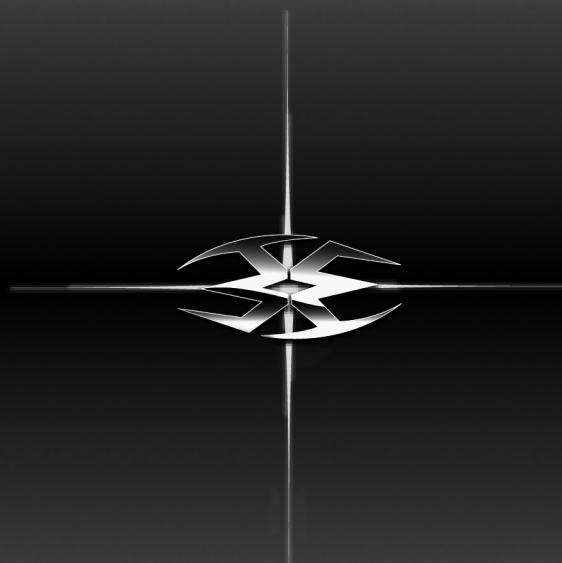

**EMPIRE PAINTBALL**  
570 Mantua Blvd.  
Sewell, NJ 08080