







INSPIRE CREATE DESTROY™



WARNING: Adhere strictly to these and all other safety instructions and guidelines.

Warnings for safe Eclipse Ego handling:

- The Eclipse Ego is not a toy.
- Careless or improper use, including failure to follow instructions and warnings within this User Manual and attached to the Eclipse Ego could cause death or serious injury.
- Do not remove or deface any warnings attached to the Eclipse Ego.
- Paintball Industry standard eye/face/ear and head protection designed specifically to stop paintballs and meeting ASTM standard F1776 (USA) or CE standard (Europe) must be worn by user and any person within range.
- Persons under 18 years of age must have adult supervision when using or handling the Eclipse Ego.
- Observe all local and national laws, regulations and guidelines.
- Use only professional paintball fields where codes of safety are strictly enforced.
- Use compressed air/nitrogen only. Do not use Co2.
- Always follow instructions, warnings and guidelines given with any first stage regulator you use with the Eclipse Ego.
- Use 0.68 calibre paintballs only.
- Keep the Eclipse Ego switched off until ready to shoot.
- Treat every marker as if it is loaded.
- Never point the Eclipse Ego at anything you do not intend to shoot.
- Do not shoot at persons at close range.

Warning
WARNING

4



WARNING

- Always measure your markers velocity before playing paintball, using a suitable chronograph.
- Never shoot at velocities in excess of 300 feet (91.44 meters) per second, or at velocities greater than local or national laws allow.
- Do not fire the Eclipse Ego without the bolt in the breech, as high-pressure gas will be emitted.
- Do not fire the Eclipse Ego without the bolt pin locked securely in place.
- Never look into the barrel or breech area of the Eclipse Ego whilst the marker is switched on and able to fire.
- Never put your finger or any foreign objects into the paintball feed tube of the Eclipse Ego.
- Never allow pressurised gas to come into contact with any part of your body.
- Always switch off the Eclipse Ego when not in use.
- Always fit a barrel-blocking device to the Eclipse Ego when not in use on the field of play.
- Always remove all paintballs from the Eclipse Ego when not in use on the field of play.
- Always remove the first stage regulator and relieve all residual gas pressure from the Eclipse Ego before disassembly.
- The Eclipse Ego can hold a small residual charge of gas, typically 2 shots, with the first stage regulator removed. Always discharge the marker in a safe direction to relieve this residual gas pressure.
- Always remove the first stage regulator and relieve all residual gas pressure from the Eclipse Ego for transport and storage.
- Always follow guidelines given with your first stage regulator for safe transport and storage.
- Always store the Eclipse Ego in a secure place.

This User Manual *Must* accompany the product in the event of resale or new ownership. Should you be unsure at any stage you *Must* seek expert advice (See Service Centers)



Orientation

This section names the component parts of the Eclipse Ego marker.

Quick Set-Up

This section provides details on how to get up and running quickly with your Eclipse Ego. This section is essential reading for everyone

- Installing a Battery
- Switching On the Eclipse Ego.
- Switching Off the Eclipse Ego.
- Firing the Eclipse Ego.
- Using the Ego Break-Beam Sensor System.

Using the Eclipse Ego

This section provides more detailed information on how to use and interact with the Eclipse Ego via its user interface.

- Setting Up
- Installing a Preset Air System
- Installing an Adjustable Air System
- Attaching a loader
- Switching on
- Screen Layout
- The Main Menu
- The Display Menu
- Using the Display Menu
- The Game Timer Menu
- Using the Game Timer Menu
- The Information Menu
- Adjusting Velocity.
- Adjusting the LPR pressure.

Advanced Set-Up

This section contains more detailed information on setting up the Eclipse Ego.

- Setting the Trigger
- The Set-Up Menu
- The Mode Menu
- Using the Mode Menu.
- The Timing Menu
- Maximum Rate of Fire (MAX ROF)
- Dwell (DWELL)
- First Shot Drop Off (FSDO)
- The Filter Menu
- Using the Break Beam Breech Sensor System
- Setting the Empty Breech Detection Time (EMPTY)
- Setting the Ball Detection Time (BALL)
- Using the Trigger Filtering
- Setting the Trigger Pull Time (PULL)
- Setting the Trigger Release Time (RELEASE)
- Using the Trigger Transition Filtering
- Setting the Trigger Transition Band (TT BAND)
- Setting the Trigger Transition Tolerance (TT TOL)
- The Factory Settings Menu
- Using the Factory Settings Menu.

Display Menu Tree

This section provides a quick reference to the User Interface.

Maintenance

This section acts as a guide to performing routine maintenance.

- Cleaning the Break Beam Sensor System.
- Stripping and Cleaning the Inline Regulator.
- Stripping and Cleaning the LPR.
- Cleaning and Lubricating the Rammer.
- How to fully strip down the Eclipse Ego (including Exhaust Valve replacement).
- Assembling the Eclipse Ego.
- Cleaning and Lubricating the bolt.

Fault Finding

This section provides information on how to resolve any problems that might arise with your Eclipse Ego.

Service Centres

This section provides information on the location of your nearest Eclipse Ego Service Centre.

Setting Savers

This section provides space for you to record your favourite Eclipse Ego settings.

Parts List

This section provides a table of the Eclipse Ego Electro-pneumatic marker components with their corresponding order codes.

Glossary

This section provides an explanation of the terminology used in the Eclipse Ego manual.

Warranty Card

Tear-out product registration card to be completed and returned to Planet Eclipse. Alternatively register online at www.planeteclipse.com.

Spares & Repairs

Available upgrade / repair kits for your Eclipse Ego Marker.



- This Users Manual is in English.
- It contains important safety guidelines and Instructions.
- Should you be unsure at any stage, or unable to understand the contents within this manual you must seek expert advice.



- Le mode d'emploi est en Anglais.
- Il contient des instructions et mesures de sécurité importantes.
- En cas de doute, ou s'il vous est impossible de comprendre le contenu du monde d'emploi, demandez conseil à un expert.



- Este manual de (operarios y) usuarios está en Inglés.
- Contiene importantes normas de seguridad e instrucciones.
- Si no esta seguro de algún punto o no entiende los contenidos de este manual debe consultar con un experto.



- Diese Bedienungs - und Benutzeranleitung ist in Englisch.
- Sie enthält wichtige Sicherheitsrichtlinien und -bestimmungen.
- Sollten Sie sich in irgendeiner Weise un sicher sein. Oder den inhalte dies heftes nicht versthen, lassen Sie sich bitte von einen Experten beraten.

For Your Records

Please complete the details to keep a permanent record of your purchase of an Eclipse Ego. Please note, the form is intended for your personal records only, and will not act as a suitable warranty card for your purchase. Please complete the warranty card provided in the manual or the online warranty form, which can be found at www.planeteclipse.com to validate your Eclipse warranty.

Product Purchased	Colour
Date of Purchase	Purchased From
Purchase Price	Serial Number

9

INDEX

ECLIPSE

Orientation

10

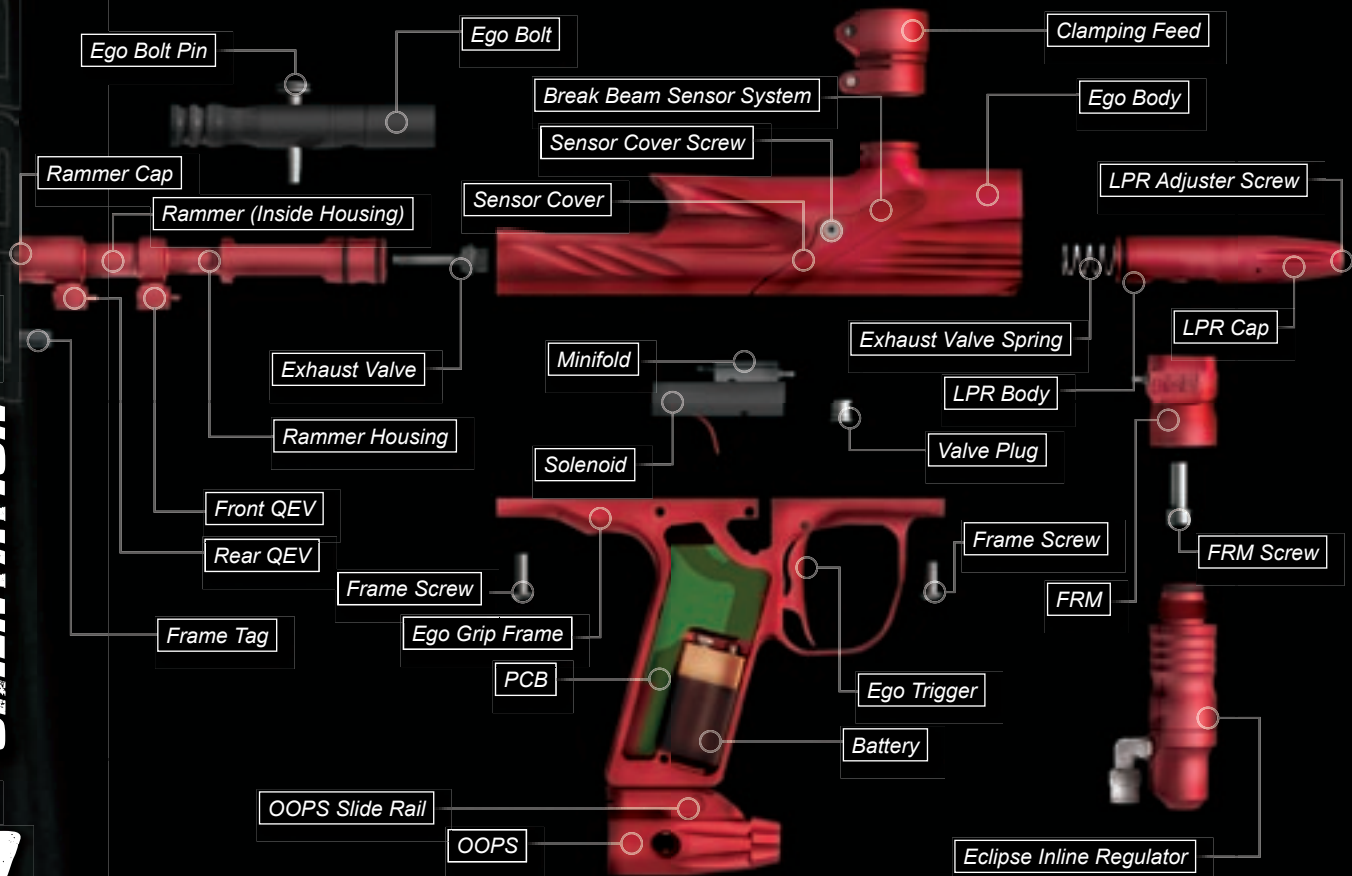

Low Pressure Regulator

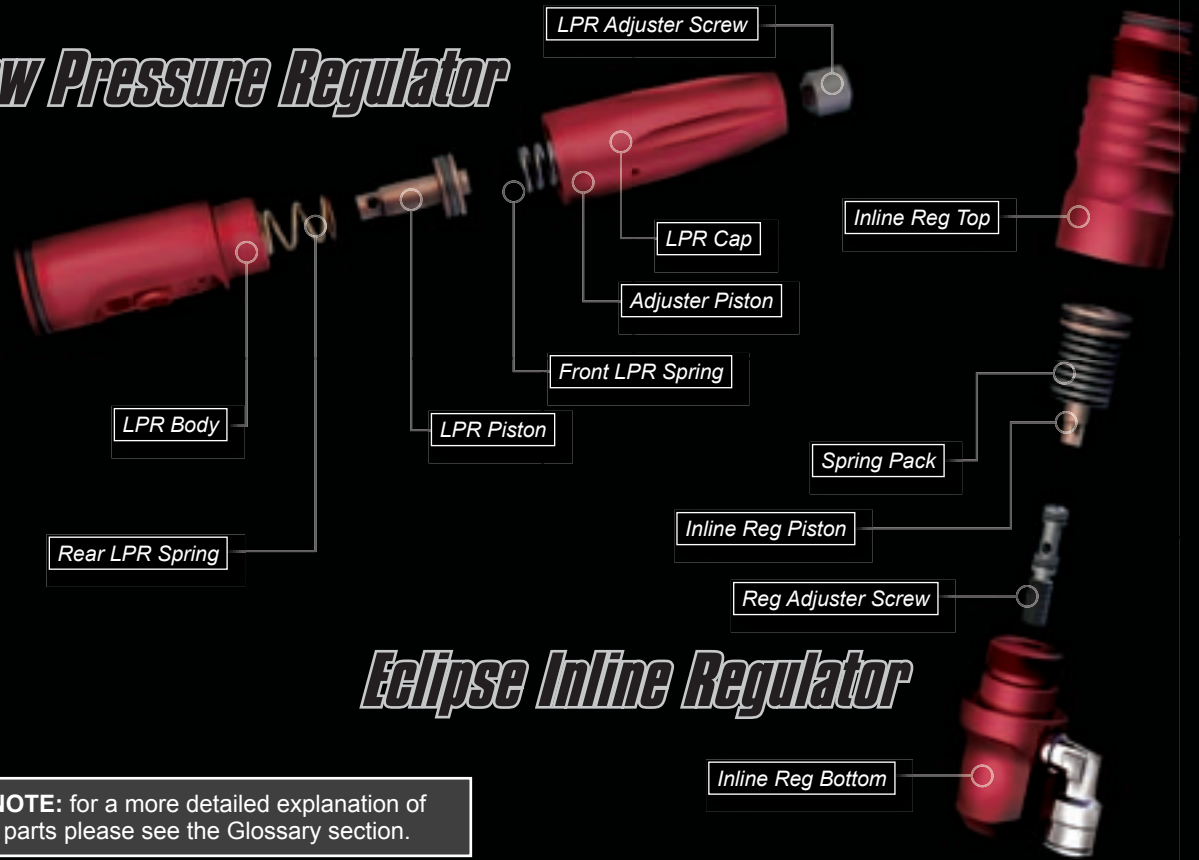

Eclipse Inline Regulator

NOTE: for a more detailed explanation of parts please see the Glossary section.

Shaft Solo Barrel



Ego Statistics

Weight	859g	Eclipse Ego and Eclipse Inline Regulator.
	1116g	Eclipse Ego and Eclipse Inline Regulator with Shaft Solo Barrel and Oops.
Length	255mm	Eclipse Ego.
	524mm	Eclipse Ego with Shaft Solo Barrel.
Height	162mm	Eclipse Ego Body and Frame.
	232mm	Eclipse Ego Body and Frame with Oops.
Width	25.3mm	Eclipse Ego.
	27.3mm	Eclipse Ego with Eye Covers.

Installing a Battery

Ensure that the Eclipse Ego is switched off. Lay the marker on a flat surface in front of you, with the feed tube furthest away and with the barrel pointing to the right.

Use a 5/64" hex wrench to remove the three countersunk screws that hold the rubber grip onto the frame (Note: a 2mm hex key can also be used). Peel the grip to the right to expose the electronics within the frame.

If present, remove the existing battery by sliding your thumb into the recess below the battery and levering the battery out of the frame *(See Figure 2.1)*.

Do Not pull on the top of the battery to remove it as this can cause the battery terminals to bend and will result in a poor electrical connection.

Fit a 9-volt alkaline battery (type PP3, 6LR61 or MN1604) into the recess with the battery terminals away from you. The positive terminal should be on the right hand side, nearest to the side of the frame *(See Figure 2.2)*.

Ensure that all of the wires are within the recess of the frame then replace the rubber grip and replace the three countersunk screws. **Do Not** over-tighten the screws.



FIGURE 2.1



FIGURE 2.2

Switching On the Eclipse Ego

At the rear of the frame, are three recessed pushbuttons. Press and hold the centre pushbutton (See Figure 2.3). After one second the Eclipse Ego logo will be displayed. Release the pushbutton and the display will revert to the designated run screen (Rate of Fire, Shot Counter or Game Timer).

Switching Off the Eclipse Ego

Press and hold the centre pushbutton for 1 second. The display will read **OFF**. Release the centre pushbutton and re-press it to turn off the Eclipse Ego. Alternatively when the display reads **OFF**, you can also pull the trigger once to turn off the Eclipse Ego.



Firing the Eclipse Ego



Pull the trigger to fire the Eclipse Ego. The entire firing sequence is controlled electronically by the Eclipse Ego circuit board and solenoid, enabling any user to achieve high rates of fire easily.



FIGURE 2.3

Using the Break Beam Sensor System

To switch off the Break Beam Sensor System, press and hold the top pushbutton for one second (See Figure 2.4).

The eye on icon  in the top left hand corner of the LCD screen will change to the eye off icon  indicating that the breach sensor has been disabled.

To switch the Break Beam Sensor System back on, press and hold the top pushbutton for one second. The eye off icon  in the top left hand corner of the LCD screen will change to the eye on icon  indicating that the breach sensor has been enabled.

When the Break Beam Sensor System is enabled, the icon will change depending on if the system has detected a ball or not. When no ball has been detected the icon looks like this  when a ball has been detected the icon changes to look like this. 

Note: when turning on the Eclipse Ego, the Break Beam Sensor System is automatically enabled.

FIGURE 2.4

1st

Orinck Soft-Up
QUICK SET-UP

ECLIPSE 

Setting Up

Before you can begin to use your Eclipse Ego, there are a few necessary components that are required to enable the Eclipse Ego to function; namely an air system and a loader of your choice.

Note: The Eclipse Ego cannot be used with Co2, it can only be powered by Compressed Air or Nitrogen.

Installing a Preset Air System

Every Eclipse Ego comes complete with an Eclipse On/Off Purge System (OOPS) allowing a preset regulator and tank to be screwed straight in for immediate use. Before screwing the preset system into the OOPS ensure that the on/off knob is wound out approximately half way *(See Figure 3.1)*. Be careful not to unscrew the on/off knob too far as it will come completely out of the OOPS. If this happens, replace the on/off knob by screwing it back into the OOPS in a clockwise direction.

Screw the preset air system into the OOPS *(See Figure 3.2)* so that the bottle screws in all the way and is tight. Slowly turn the on/off knob in a clockwise direction allowing the OOPS to depress the pin of the preset air system, causing the Eclipse Ego to become pressurised, providing there is sufficient air in your tank *(See Figure 3.3)*. You have now installed a preset air system to your Eclipse Ego.

Note: When utilising an OOPS on your Eclipse Ego, the Eclipse Ego will store air in the valve chamber after the OOPS has dumped the supply in your gas line and inline regulator. Please remember to discharge the stored air in a safe direction as you are unscrewing the on/off knob on the OOPS.



FIGURE 3.1



FIGURE 3.2



FIGURE 3.3

Installing an Adjustable Air system



FIGURE 3.4

Firstly disconnect the 1/4" hosing from the elbow attached to the OOPS at the base of the frame (*See Figure 3.4*). Unscrew the on/off knob from the OOPS, and using a 3/32" Hex key turn the two screws on the left hand side of the OOPS rail counter clockwise so that the body of the OOPS can be removed by sliding it out (*See Figure 3.5*). Using a 5/32" hex key remove the two screws that attach the OOPS rail to the bottom of the Eclipse Ego grip frame and remove the OOPS rail (*See Figure 3.6*).



FIGURE 3.5

Attach the air system of your choice, taking care to ensure that you use the correct length and size of hosing and elbows to accommodate your requirements.



FIGURE 3.6

⚠ WARNING: Before attaching any fixed air system, place attaching screw in designated slide rail and measure protruding screw length. Screw length must not protrude more than 10mm/ 0.40" otherwise the Ego Printed Circuit Board will become damaged.

Attaching a Loader

Using a 5/32" hex key, turn the top screw of the clamping feed tube counter clockwise until the feed neck of your loader can easily be pushed into the top of the clamping feed tube *(See Figure 3.7)*. Push your choice of loader firmly into the clamping feed tube so that it rests on the shelf inside the clamping feed tube *(See Figure 3.8)*. Using a 5/32" hex key, tighten the top screw of the clamping feed tube by turning it clockwise until the loader is firmly gripped *(See Figure 3.9)*.

You have now attached a loader to your Eclipse Ego. Once you have filled your loader and air tank you will then be ready to begin using your Eclipse Ego.

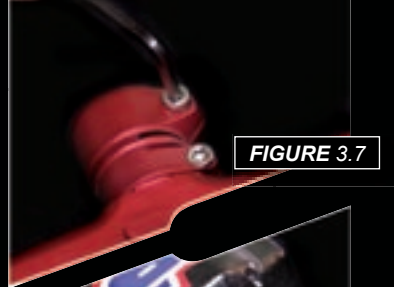

FIGURE 3.7

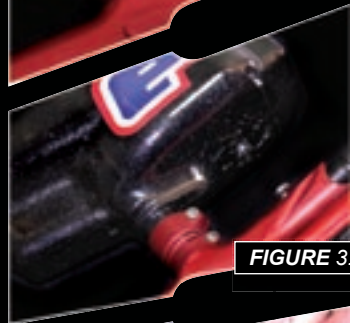

FIGURE 3.8



FIGURE 3.9

Switching On

Pressing and holding the **Select** (middle) pushbutton will switch the Eclipse Ego on. The LCD display will show the Eclipse Ego logo. When the pushbutton is released, the LCD display will show the designated display screen.

Screen Layout

The standard layout of an Eclipse Ego display is as follows:

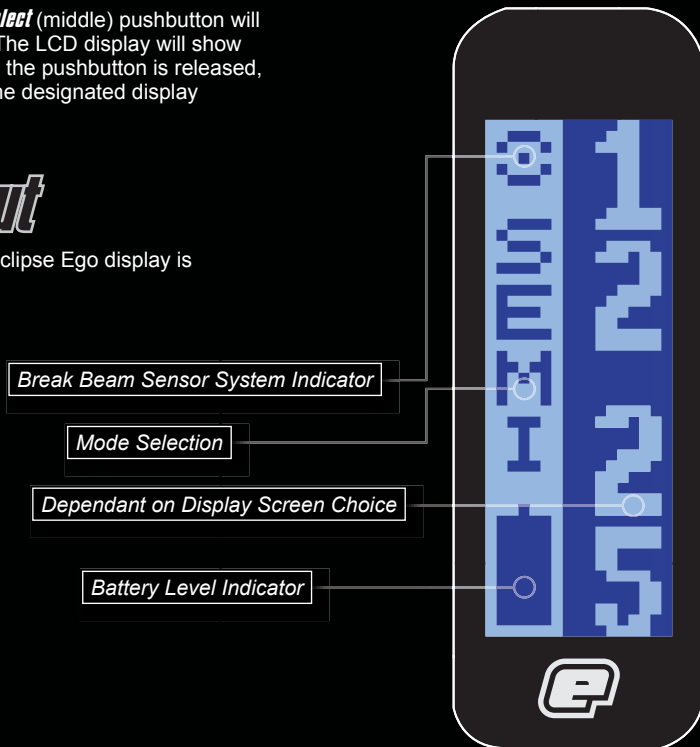

The Main Menu

To activate the Main Menu (providing the Eclipse Ego is already turned on), press and hold the **Select** pushbutton. After one second **OFF** will be displayed. This is one of the options on the Main Menu, as shown below:

Lower



Raise

Press the **Lower** (bottom) pushbutton to scroll down through each of the options on the menu. Once the last option on the menu has been displayed, pressing the **Lower** pushbutton will cause the first option to be displayed.

Press the **Raise** (top) pushbutton to scroll up through each of the options on the menu. Once the first option on the menu has been displayed, pressing the **Raise** pushbutton will cause the last option to be displayed.

Press the **Select** pushbutton to select the displayed option.

Selecting the **BACK** option will return the display to the display from which the Main Menu was selected.

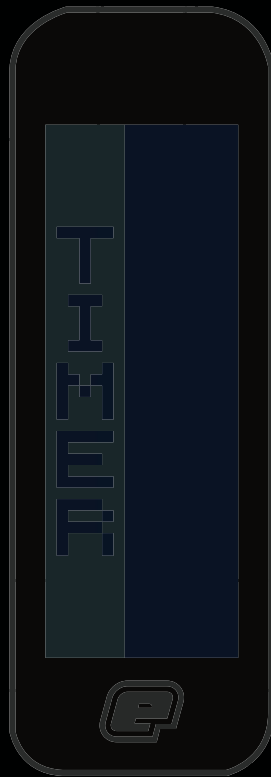

The Display Menu

Scroll through the main menu until the **DISPLAY** option is displayed and then press **Select**. This has now activated the **DISPLAY** Menu.

The left hand side of the screen shows **DISPLAY**, the name of the option that you are currently in, whilst the right hand side of the screen can be changed by using the **Raise** and **Lower** pushbuttons to scroll through the different **DISPLAY** options as detailed below:

To display the Game Timer when the frame is in normal use, simply

Select the **TIMER** option from the **DISPLAY** Menu.

To display the Shot Counter when the frame is in normal use, simply **Select** the **SHOTS** option from the **DISPLAY** Menu.

To display the Rate of Fire Indicator when the frame is in normal use, simply **Select** the **ROF** option from the **DISPLAY** menu.

Lower

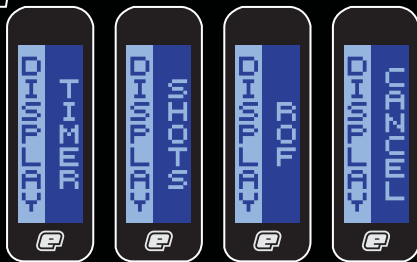

Raise

To return to the Main Menu, scroll to the **CANCEL** option and press **Select**.

NOTE: The option chosen in the **DISPLAY** menu will be the designated run screen when the Eclipse Ego is in normal use, and when the marker is first switched on.

21

Using The Ego

ECLIPSE

Using the Display Menu

As both the **TIMER** and the **SHOTS** options from the **DISPLAY** Menu are covered in their respective sections in the following pages we will start by looking at the Rate of Fire option.

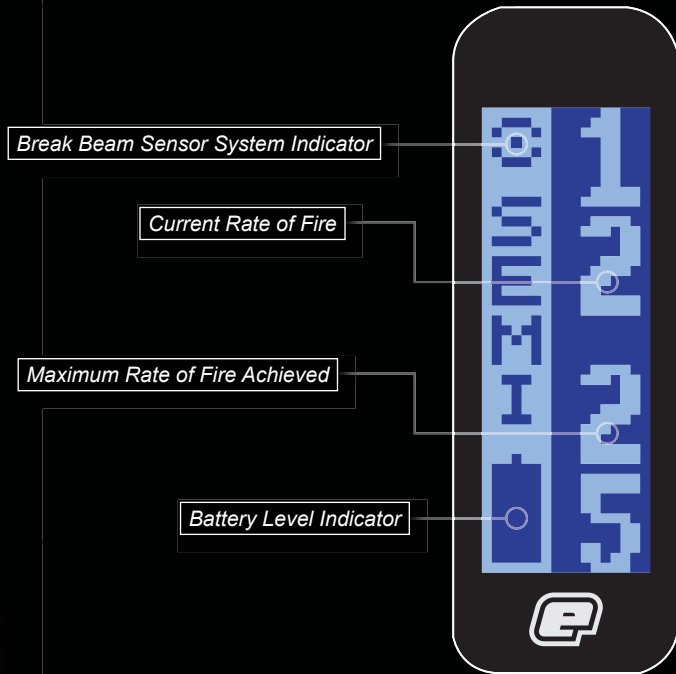

Rate of Fire Option

The Rate of Fire (**ROF**) option is a means by which you can monitor your rate of fire whilst using the Eclipse Ego. The Rate of Fire screen looks like the screen to the left.

With the Break Beam Sensor System enabled and paint present, the rate of fire is only limited to the speed of your loader. To achieve the highest rates of fire we recommend using a high-speed loader such as the HALO, Evolution 2 or Q-loader. With the Break Beam Sensor System enabled, and no paint present, the rate of fire will be 0, as your Eclipse Ego will not be able to fire.

To use the Rate of Fire screen without shooting paint, simply switch the Break Beam Sensor System off using the **Raise** pushbutton. In this scenario, the Rate of Fire is only limited to whatever value you have selected in the **MAX ROF** option in the **TIMING** Menu.

The Rate of Fire Indicator records every pull and release of the trigger over a period of one second and calculates the number of valid shots that were fired during that period.

The current Rate of Fire is displayed in the top right hand corner. The maximum Rate of Fire that has been achieved is displayed in the bottom right hand corner.

To reset the maximum Rate of Fire simply push and hold the **Lower** pushbutton for a 1 second period.

The Game Timer Menu

Scroll through the Main Menu until the **TIMER** option is displayed and then press Select. You have now entered the **GAME TIMER** Menu.

By using the **Raise** and **Lower** pushbuttons, you can scroll through the menu as illustrated below:

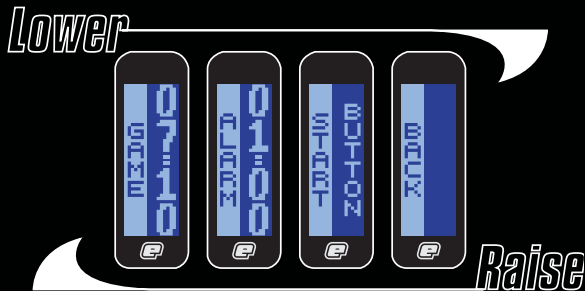

To set the game timer, simply **Select** the **GAME** option.

To set the alarm timer, simply **Select** the **ALARM** option.

To set the starting method of the game timer, simply **Select** the **START** option.

To return to the Main Menu, scroll to the **BACK** option and press **Select**.

Setting the Game Timer

Once the **GAME** option has been selected from the **GAME TIMER** Menu, the preset game time will be displayed on the right hand side of the screen, the factory setting for which is 7 minutes and 10 seconds. You will also notice that the Edit Indicators appear on the display, indicating that you are editing that particular feature, as shown on the right.

To increase the preset game time, repeatedly press and release the **Raise** pushbutton. Each time that the pushbutton is pressed, the game time will increase by 10 seconds. To increase the time more rapidly, press and hold the **Raise** pushbutton. The maximum preset game time is 60 minutes and 0 seconds, once this value has been exceeded the game timer will wrap around to 0 minutes and 0 seconds.

To decrease the preset game time, repeatedly press and release the **Lower** pushbutton. Each time that the pushbutton is pressed, the game time will decrease by 10 seconds. To decrease the time more rapidly, press and hold the **Lower** pushbutton. The minimum preset game time is 0 minutes and 0 seconds, once this value has been exceeded the game timer will wrap around to 60 minutes and 0 seconds.

Once you have set the game timer to the preset time that you require, press the **Select** pushbutton to save the value. The Edit Indicators will disappear, indicating that the time has been accepted.



Edit Indicators

Setting the Alarm Time

As well as a game timer we have an added **Alarm** feature that allows you to set a designated time during the game timer at which the **Alarm** feature will be activated. When the game timer reaches the Alarm time the display will flash repeatedly for 5 seconds to indicate this.

Once the **ALARM** option has been selected from the **GAME TIMER** Menu, the edit indicators will appear and the preset alarm time will be displayed on the right hand side of the screen, the factory setting for which is 1 minute and 0 seconds.

To increase the preset alarm time, repeatedly press and release the **Raise** pushbutton. Each time that the pushbutton is pressed, the alarm time will increase by 1 second. To increase the time more rapidly, press and hold the **Raise** pushbutton. The maximum preset alarm time is 60 minutes and 0 seconds, once this value has been exceeded the alarm timer will wrap around to 0 minutes and 0 seconds.

To decrease the preset alarm time, repeatedly press and release the **Lower** pushbutton. Each time that

the pushbutton is pressed, the alarm time will decrease by 1 second. To decrease the time more rapidly, press and hold the

Lower pushbutton. The minimum preset alarm time is 0 minutes and 0 seconds, once this value has been exceeded the alarm timer will wrap around to 60 minutes and 0 seconds.

Once you have set the alarm time to the preset time that you require, press the **Select** pushbutton to save the value. The edit indicators will disappear, indicating that the time has been accepted.

Setting the Start Method of the Game Timer

Once the **START** option has been selected from the **GAME TIMER** Menu, the edit indicators will appear and the preset method of starting the Game Timer will be displayed on the right hand side of the screen, the factory setting for which is **BUTTON**.

To change the starting option for the Game Timer, simply use the **Raise** or **Lower** pushbuttons to scroll through the menu choices: (See Figure 3.10)

BUTTON means that pressing the **Lower** pushbutton will start the game timer (when displayed).

TRIGGER means that pulling the trigger will start the game timer (when displayed).

Selecting **CANCEL** returns to the **GAME TIMER** Menu.

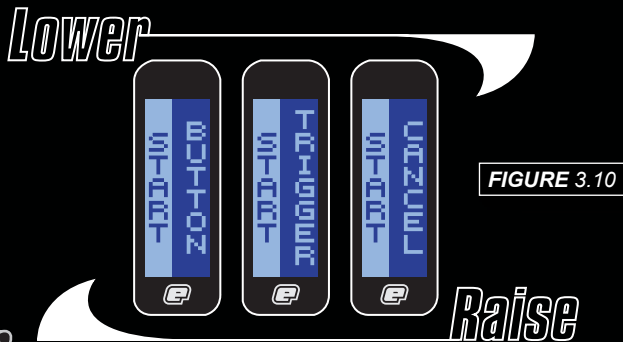

FIGURE 3.10

Starting the Game Timer

When **TIMER** has been selected as the designated Display screen, the Game Timer will be displayed.

Starting the Game Timer depends on whether you have chosen **BUTTON** or **TRIGGER** in the **START** option of the **GAME TIMER** Menu (detailed on the left). By starting the Game Timer using your chosen method, the timer will start to count backwards, in seconds, towards zero.

To stop the Game Timer, push and release the **Lower** pushbutton. The Game Timer will pause at whatever time it had counted down to.

To now reset the Game Timer, press and hold the **Lower** pushbutton for 1 second. The Game Timer will return to its preset value. The Game Timer will also be reset whenever the Eclipse Ego is switched off.

The Information Menu

Scroll through the Main Menu until the **INFO** option is displayed and then press **Select**. You have now entered the **INFORMATION** Menu .

By using the **Raise** and **Lower** pushbuttons, you can scroll through the **INFO** Menu as illustrated below:

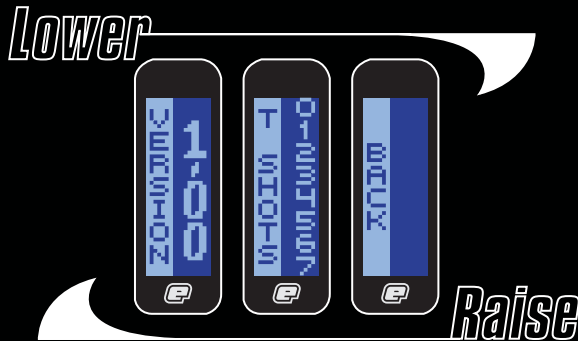

In the **INFO** Menu, the Eclipse Ego displays the current version of firmware that it has programmed into it, and the total number of shots that the frame has fired.

There is no user interaction in the **INFORMATION** Menu, it is simply a way of finding out facts about your Eclipse Ego.

To display the current Version of Firmware being used, scroll to the **VERSION** option.

To display the Total number of shots that your Ego has fired, scroll to the **T SHOTS** option.

To return to the Main Menu, scroll to the **BACK** option and press **Select**.

Adjusting Your Velocity

When using your Eclipse Ego, you may wish to change the velocity at which your Eclipse Ego is firing. This is done by inserting a 1/8th" hex key into the adjuster screw at the bottom of your Eclipse Ego Inline regulator and adjusting it accordingly *(See Figure 3.10)*. By turning this adjuster screw clockwise you decrease the output pressure of the inline regulator and consequently the velocity, by turning the adjuster screw counter clockwise you increase the output pressure of the inline regulator and consequently the velocity.



FIGURE 3.10

Note: after each adjustment fire two clearing shots to gain an accurate velocity reading. Never exceed 300fps.

Adjusting your LPR Pressure

When using your Eclipse Ego, you may wish to change the output pressure of your LPR. This is easily done by inserting a 5/32nd" inch hex key into the adjuster screw at the front and adjusting it accordingly *(See Figure 3.11)*. By turning the adjuster screw clockwise, you decrease the output pressure of your LPR and consequently reduce the pressure driving your hammer back and forth. By turning the adjuster screw counter clockwise, you increase the output pressure of your LPR and consequently increase the pressure driving your hammer back and forth.



FIGURE 3.11

Note: turning the adjuster screw out too far will cause it to fall out.

Setting The Trigger

There are three adjustment points on the trigger - the **Front Stop Trigger Screw**, the **Rear Stop Trigger Screw** and the **Return Strength Trigger Screw**.

As standard each Eclipse Ego comes with a factory-set trigger travel of approximately 2mm in total length: one millimetre of travel before the firing point, and one millimetre of travel after the firing point.

The **Front Stop Trigger Screw** is used to set the amount of trigger travel prior to the marker firing. Turn this screw clockwise to reduce the amount of travel. Do not turn the screw too far or the trigger will be pushed past its firing point and the marker will not work. Turn this screw counter clockwise to increase the amount of trigger travel (*See Figure 4.1*)

The **Rear Stop Trigger Screw** is used to set the amount of trigger travel after the marker has fired. Turn this screw clockwise to reduce the amount of travel. Do not turn the screw too far or the trigger will be prevented from reaching its firing point and the marker will not work. Turn this screw counter clockwise to increase the amount of trigger travel (*See Figure 4.2*)

The **Return Strength Trigger Screw** is used to adjust the amount of force with which the trigger is returned to its rest position. Turn the screw clockwise to increase the amount of force (*See Figure 4.3*). Do not turn the screw too far or it will negate the position of the Front Stop Trigger Screw. Turn the screw counter clockwise to reduce the amount of force. Do not turn the screw too far or there will not be enough force to return the trigger.

Once you have set the trigger to your preference, refer to setting the **TT BAND** (*see page 37*), as it is very important that the **TT BAND** and trigger pull are set up together for the Trigger Transition Filtering to work correctly.



FIGURE 4.1

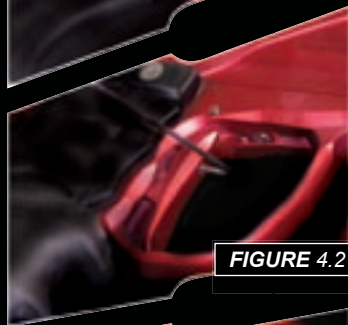

FIGURE 4.2



FIGURE 4.3

The Set Up Menu

To activate the **SET-UP** Menu, first remove the three rubber grip screws from the right hand side of the frame (See Figure 4.4) and peel back the rubber grip to expose the PCB inside the frame. Press and hold the **Set-up** pushbutton, which is located on the PCB above the battery (See Figure 4.5). After one second, the **MODE** parameter will be displayed - this is the first item on the **SET-UP** Menu (See Figure 4.6)

FIGURE 4.4

Lower

FIGURE 4.6



Raise

Press the **Lower** pushbutton to scroll down through each of the items on the menu. Once the last item has been displayed, pressing the **Lower** pushbutton will cause the first item to be displayed.

Press the **Raise** pushbutton to scroll up through each of the items on the menu. Once the first item has been displayed, pressing the **Raise** pushbutton will cause the last item to be displayed.

Press the **Select** pushbutton to select the displayed item.

Selecting **BACK** will return the display to the display from which the **SET-UP** Menu was selected.

FIGURE 4.5

The Mode Parameter

The **Mode** Parameter is used to control the firing mode of the Ego. Please Note: Certain modes may only be available in certain countries and on certain models of Eclipse Ego.

Scroll through the **Set-up** menu until the **Mode** parameter is displayed. The current firing mode is shown on the right-hand side of the display. To change the **Mode** parameter press **Select** and the edit indicators will appear (See Figure 4.8)

Press the **Lower** pushbutton to scroll down through each of the available firing mode options. Once the last option has been displayed, pressing the **Lower** pushbutton will cause the first option to be displayed.

Press the **Raise** pushbutton to scroll up through each of the available firing mode options. Once the first option has been displayed, pressing the **Raise** pushbutton will cause the last option to be displayed.

Press the **Select** pushbutton to change the firing mode to the displayed option.

Selecting **BACK** will return the display to the **Set-up** Menu.

The Timing Menu

The **TIMING** Menu provides access to parameters which control the Ego's firing cycle.

Scroll through the **Set-up** Menu until **TIMING** is displayed and then press **Select**. This will display **MAX ROF** the first item on the **TIMING** Menu (See Figure 4.7)

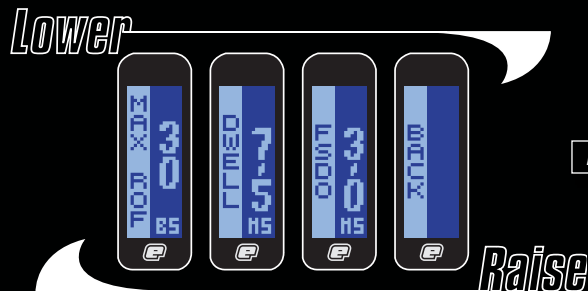

FIGURE 4.7

Press the **Lower** pushbutton to scroll down through each of the items on the **TIMING** Menu. Once the last item has been displayed, pressing the **Lower** pushbutton will cause the first item to be displayed.

Press the **Raise** pushbutton to scroll up through each of the items on the **TIMING** Menu. Once the first item has been displayed, pressing the **Raise** pushbutton will cause the last item to be displayed.

Press the **Select** pushbutton to edit the displayed parameter.

Selecting **BACK** will return the display to the **Set-up** Menu.

Maximum Rate of Fire

The **MAX ROF** parameter is used to control how fast the Ego cycles when the Break Beam Sensor System is disabled. This parameter should be set to match the slowest speed of the loading system in use.

Scroll through the **Timing** Menu until the **MAX ROF** parameter is displayed.

The current value of the **Maximum Rate of Fire** is shown in balls per second on the right hand side of the display. Press the **Select** pushbutton to enter the edit function (See Figure 4.8)

Press and release the **Raise** pushbutton to increase the **MAX ROF** value in 1 ball per second increments. Up to a maximum of 30 bps. Press and hold the **Raise** pushbutton to increase the **MAX ROF** value more rapidly.

Press and release the **Lower** pushbutton to decrease the **MAX ROF** value in 1 ball per second increments. Down to a minimum of 1 bps. Press and hold the **Lower** pushbutton to decrease the **MAX ROF** value more rapidly.

Press **Select** to save the **MAX ROF** value and the edit indicators will disappear from the display to indicate that the value has been accepted. You have now returned to the **Timing** Menu.

FIGURE 4.8

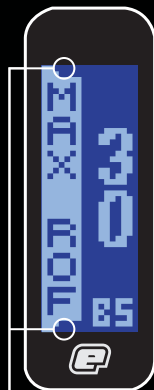

Edit Indicators

Dwell

The Dwell parameter controls the amount of time that the solenoid is energised and therefore the amount of gas that is released with each shot.

Scroll through the **Timing** Menu until the **DWELL** parameter is displayed.

The current value of the **DWELL** is shown on the right hand side of the display (See Figure 4.9)

Press the **Select** pushbutton to enter the edit function and the edit indicators will appear on the display.

Press and release the **Raise** pushbutton to increase the **DWELL** time in 0.1 millisecond increments. Press and hold the **Raise** pushbutton to increase the **DWELL** time more rapidly.

Press and release the **Lower** pushbutton to decrease the **DWELL** time in 0.1 millisecond increments. Press and hold the **Lower** pushbutton to decrease the **DWELL** time more rapidly.

Press **Select** to save the **DWELL** time and the edit indicators will disappear from the display to indicate that the value has been accepted. You have now returned to the **Timing** Menu.



FIGURE 4.9

31

ADVANCED SET-UP

ECLIPSE 

First Shot Drop Off

First shot drop off is a reduction in velocity of the first paintball to be fired after the Ego has been left un-fired for any length of time. The **FSDD** parameter is used to define an increase in dwell time for the 'First Shot' in order to combat this problem.

Scroll through the **Timing** Menu until the **FSDD** parameter is displayed.

The current value of the **First Shot Drop Off** is shown on the right hand side of the display (See Figure 4.10)

Press the **Select** pushbutton to enter the edit function and the edit indicators will appear on the display.

Press and release the **Raise** pushbutton to increase the **FSDD** value in 0.1ms increments. Press and hold the **Raise** pushbutton to increase the **FSDD** value more rapidly.

Press and release the **Lower** pushbutton to decrease the **FSDD** value in 0.1ms increments. Press and hold the **Lower** pushbutton to decrease the **FSDD** value more rapidly.

Press **Select** to save the **FSDD** value and the edit indicators will disappear from the display to indicate that the value has been accepted.

You have now returned to the **Timing** Menu.

FIGURE 4.10



The Filter Menu

The **FILTER** Menu provides access to parameters that are used to control the various software filters.

Scroll through the **Set-up** Menu until the **FILTER** is displayed and then press **Select**. This will display **EMPTY**, the first item on the **Filter** Menu (See Figure 4.11)

Press the **Lower** pushbutton to scroll down through each of the items on the **Filter** Menu. Once the last item has been displayed, pressing the **Lower** pushbutton will cause the first item to be displayed.

Press the **Raise** pushbutton to scroll up through each of the items on the **Filter** Menu. Once the first item has been displayed, pressing the **Raise** pushbutton will cause the last item to be displayed.

Press the **Select** pushbutton to edit the displayed parameter.

Selecting **BACK** will return the display to the **SET-UP** Menu.

FIGURE 4.11

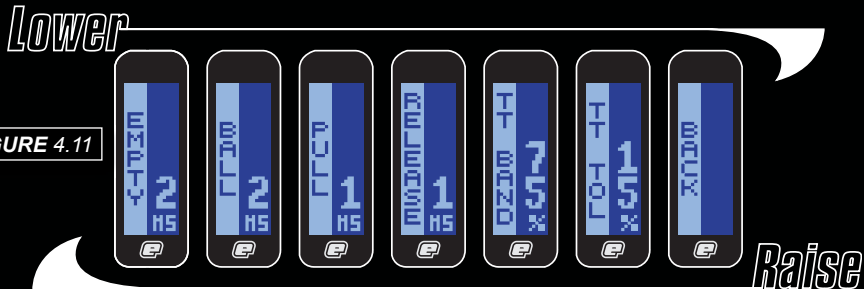

Using the Break Beam Sensor System

During the firing cycle, the breech sensor looks first for an empty breech and then for a paintball within the breech. Only when the sensor has detected both conditions will it allow the Eclipse Ego to be fired. The sensor software

filter allows you to fine tune the operation of the Break Beam sensor system by allowing you to specify how long the sensors have to see an 'empty' breech for and how long they have to see a ball for.

Setting the Empty Breech Detection Time

Custom and third party bolts can fool the BBSS if they have slots or holes that allow the Break Beam to pass through. To overcome this problem the **EMPTY** parameter defines how long the Break Beam has to be in-tact before the breech is considered to be empty.

Scroll through the **Filter** Menu until the **EMPTY** parameter is displayed.

The current value of the **Empty Breech Detection Time** (EMPTY) is shown on the right hand side of the display (See Figure 4.12)

Press the **Select** pushbutton to enter the edit function and the edit indicators will appear on the display.

Press and release the **Raise** pushbutton to increase the **EMPTY** value in 1 millisecond increments. Press and hold the **Raise** pushbutton to increase the **EMPTY** value more rapidly.

Press and release the **Lower** pushbutton to decrease the **EMPTY** value in 1 millisecond increments. Press and hold the **Lower** pushbutton to decrease the **EMPTY** value more rapidly.

Press **Select** to save the **EMPTY** value and the edit indicators will disappear from the display to indicate that the value has been accepted. You have now returned to the **Filter** Menu.



FIGURE 4.12

33

Advanced Set-Up

ECLIPSE

Setting the Ball Detection Time

The **BALL** parameter defines how long a paintball has to sit in the breach before it is considered ready to fire.

Scroll through the **Filter** Menu until the **BALL** parameter is displayed.

The current value of the **Ball Detection Time** is shown on the right hand side of the display (See Figure 4.13)

Press the **Select** pushbutton to enter the edit function and the edit indicators will appear on the display.

Press and release the **Raise** pushbutton to increase the **BALL** value in 1-millisecond increments. Press and hold the **Raise** pushbutton to increase the **BALL** value more rapidly.

Press and release the **Lower** pushbutton to decrease the **BALL** value in 1-millisecond increments. Press and hold the **Lower** pushbutton to decrease the **BALL** value more rapidly.

Press **Select** to save the **BALL** value and the edit indicators will disappear from the display to indicate that the value has been accepted. You have now returned to the **Filter** Menu.



FIGURE 4.13

Using the Trigger Filtering

The trigger has to be pulled for a specific time in order for that trigger pull to be accepted as a valid trigger pull. The Eclipse Ego cannot be fired until it has had a valid trigger pull.

The trigger then has to be released for a specific time in order for that release to be accepted as a valid trigger release. The Eclipse Ego cannot be fired again until it has first had a valid trigger release (followed, of course, by another valid trigger pull).

With the addition of the Trigger Transition software filter (see page. 36), you can minimise the time that the trigger has to be pulled for and how long it has to be released for to maintain high rates of fire whilst eliminating the risk of 'Trigger Bounce'

Setting the Trigger Pull Time

Scroll through the **Filter** Menu until the **PULL** parameter is displayed.

The current value of the trigger pull time is shown on the right hand side of the display **[See Figure 4.14]**

Press the **Select** pushbutton to enter the edit function and the edit indicators will appear on the display.

Press and release the **Raise** pushbutton to increase the **PULL** value in 1-millisecond increments. Press and hold the **Raise** pushbutton to increase the **PULL** value more rapidly.

Press and release the **Lower** pushbutton to decrease the **PULL** value in 1-millisecond increments. Press and hold the **Lower** pushbutton to decrease the **PULL** value more rapidly.

Press **Select** to save the **PULL** value and the edit indicators will disappear from the display to indicate that the value has been accepted. You have now returned to the **Filter** Menu.

Assuming the TT filter is correctly set, the **PULL** parameter can be set to 0ms for fastest trigger operation.

FIGURE 4.14



Setting the Trigger Release Time

Scroll through the **Filter** Menu until the **RELEASE** parameter is displayed.

The current value of the trigger release time is shown on the right hand side of the display **[See Figure 4.15]**

Press the **Select** pushbutton to enter the edit function and the edit indicators will appear on the display.

Press and release the **Raise** pushbutton to increase the **RELEASE** value in 1-millisecond increments. Press and hold the **Raise** pushbutton to increase the **RELEASE** value more rapidly.

Press and release the **Lower** pushbutton to decrease the **RELEASE** value in 1-millisecond increments. Press and hold the **Lower** pushbutton to decrease the **RELEASE** value more rapidly.

Press **Select** to save the **RELEASE** value and the edit indicators will disappear from the display to indicate that the value has been accepted. You have now returned to the **Filter** Menu.

Assuming the TT filter is set correctly, the **RELEASE** parameter can be set to 1ms for fastest trigger operation. On short triggers this may have to be increased to prevent 'Double Taps'.

FIGURE 4.15



35

ADVANCED SET-UP

ECLIPSE

Using the Trigger Transition Filtering

The Eclipse Ego incorporates an advanced debounce (anti-bounce) algorithm known as the **Trigger Transition Filter (TT Filter)**, which is fully adjustable and can be used to completely eliminate trigger bounce.

The **TT Filter** works by analysing each trigger pull and determining whether that trigger pull is a legitimate pull of the trigger by the user, or one that has been caused by the gun bouncing, in which case the algorithm will

take steps to stop that bounce by varying the cycle time of the marker.

There are two adjustable parameters associated with the **TT Filter**:

TT Band

This parameter defines the operating range of the **TT Filter** in terms of trigger movement. The larger the **TT Band**, the less the gun is able to bounce.

TT Tolerance

This parameter defines how strictly the **TT Filter** applies its debounce rules - the lower this value, the less the gun is able to bounce.

Setting up the TT Filter

In order to optimise the **TT Filter** it is necessary to have the **TT Band** parameter as high as possible and the **TT Tolerance** parameter as low as possible -

1. Select the **TT Band** parameter. Observe that the graphical bar rises and falls as the trigger is pulled and released. The actual value of the bar is displayed in the top right of the display.
2. Set the **post-travel trigger stop** as required and ensure that the bar is as close to 100% as possible when the trigger is fully depressed against the set screw.
3. Set the **pre-travel trigger set screw** as required and ensure that the bar is as close to 0% as possible when the trigger is fully released against the set screw.
4. Set the **trigger return force set screw** as required, making the return force as strong as possible without compromising the 'feel' of the pull.

5. Adjust the **TT Band** parameter and observe the movement of the two horizontal markers by the side of the bar. As the **TT Band** is decreased these markers move closer together, and as the **TT Band** is increased these markers move further apart. Set the **TT Band** such that when the trigger is fully depressed the bar settles above the upper marker and when the trigger is fully release the bar settles below the lower marker. *(See Figure 4.16)* This ensures that the **TT Band** operates across the full range of the trigger pull.

6. Select the **TT Tolerance** parameter. With the gun gassed up and preferably fitted with loader and firing paint, try to get the gun to bounce by pulling the trigger very slowly. If the gun does bounce then reduce the **TT Tolerance** until it no longer does so. If the gun does not bounce then increase the **TT Tolerance** until the gun does bounce and then reduce the **TT Tolerance** again until the bouncing stops.

Whilst this set up should completely eliminate bounce, it may result in a trigger pull that is not ideally suited to the user, in which case it will be necessary to make adjustments to the trigger and then modify the **TT Filter** parameters accordingly.

Note: The fastest way to shoot an Eclipse Ego is to walk the trigger with two or more fingers. Feathering (not fully releasing) the trigger will cause the TT Filter to reduce the rate of fire down in order to eliminate what it perceives as trigger bounce.



FIGURE 4.16

The Factory Setting Menu

FIGURE 4.17



The Factory settings menu gives the user a simple way of resetting their Eclipse Ego to the factory settings, without having to individually go through and adjust each parameter.

If the user has chosen to deviate from the factory settings, **FACTORY NO** will be displayed when entering the **FACTORY** Menu (See Figure 4.17)

Press the **Lower** pushbutton to scroll down through each of the options on the **Factory** Menu. Once the last option has been displayed, pressing the **Lower** pushbutton will cause the first option to be displayed.

Press the **Raise** pushbutton to scroll up through each of the options on the **Factory** Menu. Once the first option has been displayed, pressing the **Raise** pushbutton will cause the last option to be displayed.

Press the **Select** pushbutton to select the displayed option.

To reset the Eclipse Ego to Factory Settings, select the **YES** option.

To keep the Eclipse Ego settings the same, select the **NO** option.

It is not possible to select **CUSTOM** as an option from the **FACTORY** Menu, as this is only displayed when Factory Settings are not adhered to.

Selecting **CANCEL** will terminate the selection mode leaving the original choice unchanged and return you to the **Set-up** Menu. (See Figure 4.18)

Using the Factory Menu

Scroll through the **Set-up** Menu until the **FACTORY** parameter is displayed and then press the **Select** pushbutton to enter the **FACTORY** menu (See Figure 4.18)

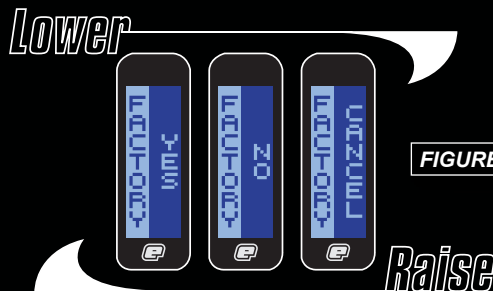

FIGURE 4.18

Main Menu	OFF DISPLAY		Turn the Eclipse Ego Off. Display Selection
	TIMER	TIMER SHOTS ROF CANCEL	Display the Game Timer Display the Shot Counter Display the Rate of Fire Cancel The Selection Go to the Timer menu Adjust the Game Timer
	INFO	GAME ALARM START BACK	Adjust the Alarm time. Choose how to start the game timer Return to the Main Menu
	BACK	VERSION T SHOTS	Go to the Info menu Display the current version of firmware. Display the total number of shots. Return to the Main Menu
Set-Up Menu	MODE	SEMI CANCEL	Operating Mode Selection Select Semi-auto Mode Cancel The Selection Go to the Timing Menu
	TIMING	MAX ROF DWELL FSDO BACK	Maximum Rate of Fire Dwell Time First Shot Drop Off Value Return to the Setup Menu
	FILTER	EMPTY BALL PULL RELEASE TT BAND TT TOL BACK	Go to the Filter Menu Empty Breech Detection Time Parameter Ball Detection Time Parameter Trigger Pull Time Parameter Trigger Release Time Parameter Trigger Transition Band Parameter Trigger Transition Tolerance Parameter Return to the Set-up Menu
	FACTORY	YES NO CANCEL	Restore Factory Settings Reset the Eclipse Ego to Factory Settings Retain Custom settings Cancel The Selection
	BACK		Return to the regular display mode.

Cleaning the Break Beam Sensor System

⚠ WARNING: De-gas your marker, discharging any stored gas in a safe direction, and remove the barrel and loader to make the Ego easier to work on.

Undo the retaining screw for the Break Beam Sensor Cover on the right hand side of the Eclipse Ego using a 5/64th" hex key (See Figure 6.1)

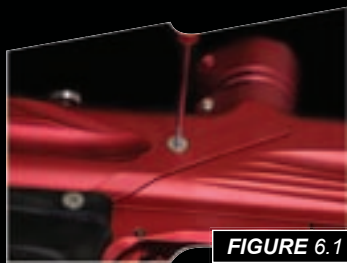

FIGURE 6.1

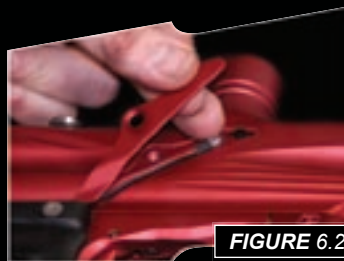

FIGURE 6.2

Remove the Sensor Cover to expose the back of the Break Beam Sensor unit (See Figure 6.2). Using a dry Q-tip, carefully remove any debris, paint or moisture from the back of the sensor unit and from inside the Sensor Cover.

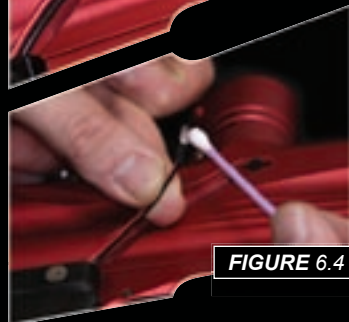

FIGURE 6.4



FIGURE 6.3

Carefully slide the sensor unit down approximately half an inch (See Figure 6.3), allowing it to be lifted free from the Eclipse Ego body and using another dry Q-tip, remove any grease or debris build-up from the front of the sensor unit (See Figure 6.4).

Remove the rubber finger detent and using a dry Q-tip clean detent and it's location point in the Eclipse Ego Body. Replace clean detent back into the Eclipse Ego body **(See Figure 6.5)** and slide sensor unit back into place **(See Figure 6.6)**.

Replace the Sensor Cover and using a 5/64th" hex key, replace the Bream Beam Sensor Cover retaining screw to hold the sensor cover in place **(See Figure 6.7)**. Be careful not to cross-thread the screw. Do not over tighten the screw.

Repeat procedure for opposite side of the Eclipse Ego.

You have now cleaned your Break Beam Sensor System.

Note: When cleaning Break Beam Sensor System inspect condition of rubber finger detents and replace if necessary. Ensure that the receiver sensor (indicated by a red mark & red heat shrink) is located on the right-hand side of the marker body.

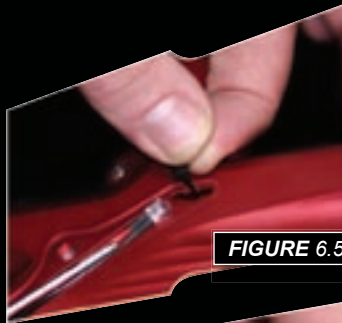

FIGURE 6.5



FIGURE 6.6

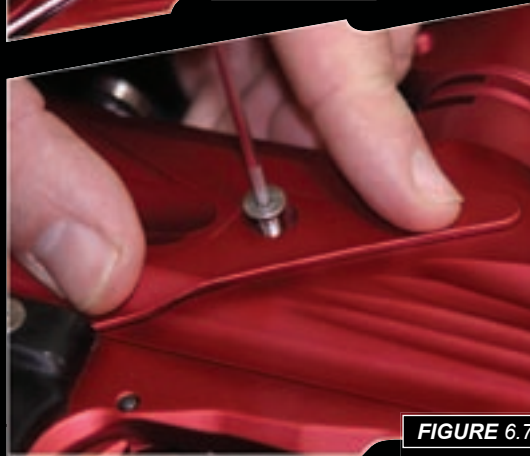

FIGURE 6.7

Cleaning the Inline Regulator



FIGURE 6.8



FIGURE 6.9



FIGURE 6.10

⚠ WARNING: De-gas your marker, discharging any stored gas in a safe direction, and remove the barrel and loader to make the Ego easier to work on.

Disconnect the hosing from your Inline Regulator allowing it to be unscrewed from the Front Regulator Mount (FRM) *(See Figure 6.8).*

Turn the Inline Regulator upside down and carefully unscrew the two sections, taking care not to lose any of the washers that form the spring pack inside the regulator *(See Figure 6.9).*

By firmly gripping the exposed base of the brass regulator piston, carefully remove the piston and spring stack in their entirety *(See Figure 6.10).*

The spring pack comprises of 16 sprung washers, which must be in the correct configuration for the inline regulator to perform at the required pressure range *(See Figure 6.11).*

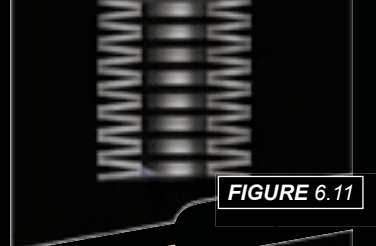

FIGURE 6.11



FIGURE 6.12

Insert a 1/8th inch hex key into the adjuster screw in the bottom half of the inline regulator, and wind the screw clockwise through the bottom section of the regulator body *(See Figure 6.12)* and pull free when it will no longer turn upwards anymore.

Note: The adjuster screw can only be removed by turning it upwards through the bottom section of the inline regulator. The regulator will become damaged if the adjuster screw is removed incorrectly.



FIGURE 6.13

Using a dry Q-tip, clean the seal that sits at the top of the body of the bottom section of the Inline regulator (*See Figure 6.13*). Using a light oil and a fresh Q-tip, re-lubricate the seal ready for re-assembly.



FIGURE 6.14

Thoroughly clean the two O-rings on the adjuster screw and lubricate ready for re-assembly (*See Figure 6.14*). Inspect top face of adjuster unit for any excessive wear or damage as this could cause inline regulator to creep (*See Figure 6.15*).



FIGURE 6.15

Note: the sealing face on the inline regulator piston can also cause the regulator to creep or “supercharge”, so this should also be checked.



FIGURE 6.16

With the threaded section towards the base of the regulator body, re-insert the adjuster screw into the bottom half of the regulator body (*See Figure 6.16*). Apply light pressure to the top of the adjuster screw and using a 1/8th" hex key wind the adjuster screw counter clockwise until it stops at the base of the regulator body. Turn the adjuster screw two full turns in a clockwise direction to set the inline regulator pressure at approximately 300 - 350 psi.

Next take the piston and spring stack and clean the seal at the top of the piston, re-lubricating it with a light smear of Vaseline ready for re-assembly (*See Figure 6.17*). Insert the piston and spring stack into the top half of the inline regulator body (*See Figure 6.18*).



FIGURE 6.17



FIGURE 6.18

Keeping the top half of the inline regulator upside down, screw the two halves of the inline regulator together (*See Figure 6.19*). You have now stripped, cleaned, lubricated and assembled your inline regulator.



FIGURE 6.19

Note: If any seals are damaged, replace as necessary. Extra seals are available in Ego parts kits available online at www.planeteclipse.com

Cleaning the LPR

⚠ WARNING: De-gas your marker, discharging any stored gas in a safe direction, and remove the barrel and loader to make the Ego easier to work on.

Inline regulator can be removed if needs be.



FIGURE 6.20

Unscrew the low-pressure regulator cap from the marker body
(See Figure 6.20).

Remove the LPR piston and rear spring from the LPR cap
(See Figure 6.21).

Cupping the palm of one hand, turn the LPR cap upside down and tip the front spring out into your palm
(See Figure 6.22).



FIGURE 6.21



FIGURE 6.22

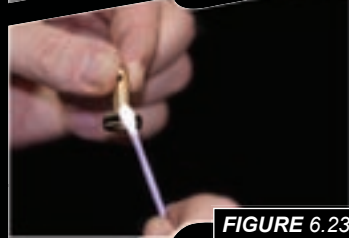

FIGURE 6.23

Remove the rear spring from the LPR piston and using a dry Q-tip, carefully clean the seal on the LPR piston *(See Figure 6.23)*. If the seal is damaged, replace as necessary. Once the seal has been cleaned, lubricate with a light smear of Vaseline, so that it is ready for re-assembly.

Note: The adjuster piston (coloured cap that the front spring rests in) does not need to be removed from the LPR cap for regular maintenance.



FIGURE 6.24

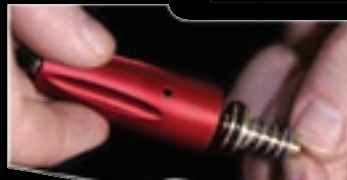

FIGURE 6.25

Insert the silver coloured spring into the LPR cap, so that it rests neatly in the adjuster piston (See figure 6.24).

Place the gold coloured spring onto the LPR piston and insert piston and spring into the LPR cap, o-ring end first (See figure 6.25).

Before screwing the LPR cap back onto your Eclipse Ego, use a dry Q-tip to clean the seal inside the LPR body (See figure 6.26). Lubricate this seal using a light 3 in 1 oil.

Replace the LPR cap by screwing it onto the LPR body in the Eclipse Ego (See figure 6.27).



FIGURE 6.27



FIGURE 6.26



FIGURE 6.28



FIGURE 6.29



FIGURE 6.30

Cleaning and Lubricating the Rammer

⚠ WARNING: De-gas your marker, discharging any stored gas in a safe direction, and remove the barrel and loader to make the Ego easier to work on.

Pull the bolt pin upwards so that it dis-engages the rammer, allowing the bolt to be removed via the rear of the Eclipse Ego *(See Figure 6.28)*.

Using a 5/32nd" hex key, unscrew and remove the rammer cap at the rear of the Eclipse Ego *(See Figure 6.29)*.

Raise the front of the Eclipse Ego and tap the Eclipse Ego onto your hand until the rammer falls into the palm of your hand *(See Figure 6.30)*.

Thoroughly clean the rammer shaft and all of its seals, paying special attention to the seal on the middle of the shaft *(See Figure 6.31)*, the rear seal *(See Figure 6.32)* and the condition of the bumper at the rear of the shaft *(See Figure 6.33)*. Replace any worn seals/bumpers using authentic Eclipse Ego spare parts.

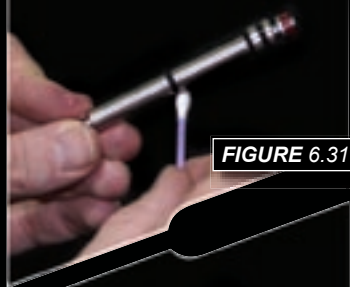

FIGURE 6.31

Lubricate all of the seals on the rammer shaft and replace the rammer into the rear of the Eclipse Ego body with the bumper at the back (See Figure 6.34). Note: Use light paintgun oil.

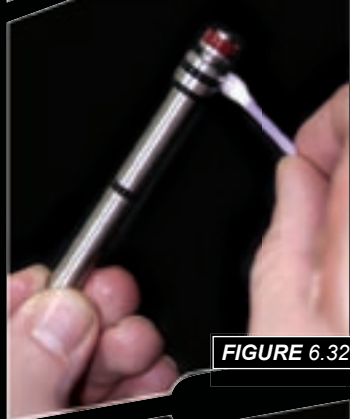

FIGURE 6.32

Replace the rammer cap, using the 5/32nd" hex key to secure it into the Eclipse Ego body (See Figure 6.35).



FIGURE 6.33



FIGURE 6.34



FIGURE 6.35

Noting the position of the rammer in the Eclipse Ego body (See Figure 6.36), replace the bolt and locate the bolt pin into the designated groove in the rammer shaft (See Figure 6.37).



FIGURE 6.36

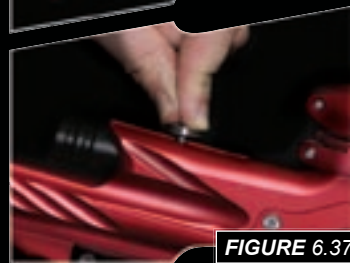

FIGURE 6.37

How to Strip the Ego

⚠ WARNING: De-gas your marker, discharging any stored gas in a safe direction, and remove the barrel and loader to make the Ego easier to work on.

Remove the bolt and bolt pin, disconnect any hosing and unscrew the inline regulator from the front bottle mount as detailed above.

Using a 5/64th" hex key remove the six screw that attach the Eclipse Ego grips to the Eclipse Ego frame (See Figure 6.38).

Unplug the solenoid and unplug the break beam sensors from their ports on the Eclipse Ego printed circuit board (See Figure 6.39).

Using a 1/8th" hex key undo the two frame retaining screws (See Figure 6.40) and remove the frame from the Eclipse Ego body, taking care not to damage any wires (See Figure 6.41).

Using a 1/8th" hex key loosen the set screw that retains the frame tag, and slide the frame tag rearwards until it is free from the marker body (See Figure 6.42).

Free the hose from the barb fitting at the rear of the front regulator mount, using a pick or other suitable implement (See Figure 6.43).

Carefully lift the low-pressure hose, which runs from the rear Eclipse QEV to the minifold, clear from its groove in the Eclipse Ego body, so that the rammer assembly is ready to be removed from the Eclipse Ego body (See Figure 6.44).



FIGURE 6.40

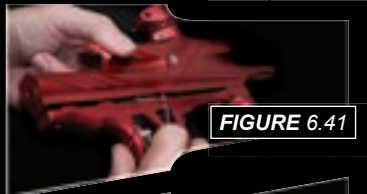

FIGURE 6.41



FIGURE 6.42



FIGURE 6.38



FIGURE 6.43



FIGURE 6.39



FIGURE 6.44

Using a 1/8th" hex key, remove the valve plug from the underside of the Eclipse Ego body *(See Figure 6.45)*.



FIGURE 6.45

Gently slide the rammer assembly rearwards until the minifold lines up with the access slot in the bottom of the Eclipse Ego body. With the Eclipse Ego upside down and facing forward, tilt the solenoid and minifold to the left freeing the right hand side of the minifold allowing both the minifold and solenoid to be freed from the Eclipse Ego body *(See Figure 6.46)*.



FIGURE 6.46

Slide the rammer assembly out of the rear of the Eclipse Ego, remembering to remove the valve and valve spring *(See Figure 6.47)*.



FIGURE 6.47

Remove the exhaust valve and valve spring from the rammer assembly, and inspect the sealing face of both the rammer assembly body and exhaust valve for any excessive wear or damage *(See Figure 6.48)*. If the exhaust valve or brass bushed valve guide is damaged then replace using authentic Eclipse Ego parts.



FIGURE 6.48



FIGURE 6.49



FIGURE 6.50



FIGURE 6.51

Taking the Eclipse Ego body, turn it so that the underside of the front regulator mount (FRM) is visible, exposing the retaining screw *(See Figure 6.49)*. Using a 3/16th" hex key remove the FRM retaining screw and remove the FRM from the Eclipse Ego body *(See Figure 6.50)*.

Once the FRM has been removed the LPR body is exposed through the bottom of the Eclipse Ego body. Slide the complete LPR out of the Eclipse Ego body *(See Figure 6.51)*.

You have now stripped down your Eclipse Ego.

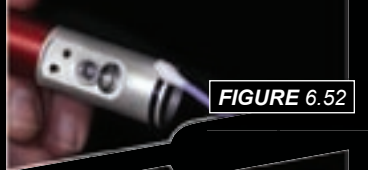

FIGURE 6.52



FIGURE 6.53



FIGURE 6.54



FIGURE 6.55



FIGURE 6.56

Assembling the Ego

Having stripped down the Eclipse Ego, here is a guide of how best to re-assemble it.

Clean and lubricate the seal at the back of the LPR body (*See Figure 6.52*). Slide the entire LPR back into the Eclipse Ego body, so that the bottom of the LPR body lines up with the FRM window in the bottom of the Eclipse Ego body (*See Figure 6.53*).

Insert the FRM, ensuring that all of the seals are in the correct place and that the FRM lines up with the bottom of the LPR body (*See Figure 6.54*). Using the 3/16th" inch hex key tighten down the FRM retaining screw to secure both the FRM and LPR in place.

Lubricate the two seals at the front of the rammer assembly (*See Figure 6.55*) and lubricate the exhaust valve shaft before inserting exhaust valve into the brass bushed valve guide (*See Figure 6.56*).



FIGURE 6.57



FIGURE 6.61



FIGURE 6.62



FIGURE 6.58



FIGURE 6.59

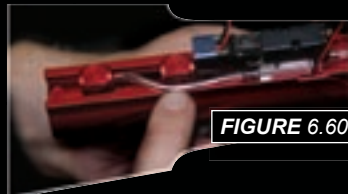

FIGURE 6.60

Remembering to include the valve spring, begin to insert the rammer assembly into the Eclipse Ego body, taking care not to damage any of the low-pressure hosing. Line the rammer assembly up so that the minifold can slide into the groove in the bottom of the Eclipse Ego body *(See Figure 6.57)*.

By applying slight pressure to the back of the rammer assembly *(See Figure 6.58)*, hold the rammer in place against the exhaust valve spring tension, so that the valve plug can be replaced *(See Figure 6.59)*.

Line the low-pressure hose up neatly in the groove provided in the Eclipse Ego body, so that it doesn't get in the way when re-attaching the grip frame *(See Figure 6.60)* and attach low-pressure hosing to the barb at the back of the FRM *(See Figure 6.61)*.

Replace the frame tag, and using a 1/8th" hex key secure the frame tag in place *(See Figure 6.62)*.

Note: Do not over-tighten frame tag screw



FIGURE 6.63



FIGURE 6.64



FIGURE 6.65



FIGURE 6.66

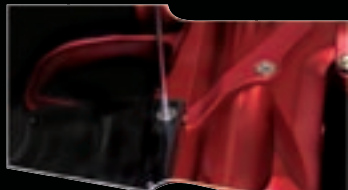

FIGURE 6.67

Assembling the Ego

Carefully thread the solenoid and Break Beam Sensor leads through the access hole in the top of the grip frame (*See Figure 6.63*), and reattach the grip frame to the marker, tightening the grip frame screws using a 1/8th" hex key (*See Figure 6.64*).

Ensure that the Break Beam Sensor cables lie neatly in the slots provided for them in the Eclipse Ego grip frame (*See Figure 6.65*). Connect the solenoid and the Break Beam Sensors into their relevant places on the Eclipse Ego PCB (*See Figure 6.66*) and re-attach the Eclipse Ego grips by securing the six grip screws using a 5/64th" hex key (*See Figure 6.67*).

Screw the inline regulator back into the FRM (*See Figure 6.68*) and connect any hosing that was disconnected (*See Figure 6.69*). Replace bolt and locate bolt pin in the designated groove in the rammer.

You have now assembled your Eclipse Ego.



FIGURE 6.68



FIGURE 6.69

Cleaning and Lubricating the Bolt

This procedure can be performed with the Eclipse Ego gassed up as well as de-gassed.

Raise the bolt pin and remove the bolt and bolt pin from the Eclipse Ego marker body.

Using a dry Q-tip remove any paint or grease from the surface of the bolt and seals on the bolt *(See Figure 6.70)*.

Lubricate the two bolt seals and replace the bolt, locking the bolt pin into the designated slot in the rammer.

Note: We recommend the use of light paintgun oil throughout the Eclipse Ego.



FIGURE 6.70

Symptom	Possible Cause	Solution
Although a fresh battery has been fitted, the Eclipse Ego will not switch on.	The battery has been fitted incorrectly.	Fit the battery correctly with the positive terminal nearest to the side of the frame.
	The battery terminals are not making proper contact with the battery.	Remove the battery, gently bend the terminals towards where the battery will sit and then replace the battery.
The battery does not seem to last very long.	The battery type is of a low quality.	Use an alkaline or metal hydride battery. Do not use a low quality or rechargeable battery.
Eclipse Ego leaks from solenoid area.	Check that 3 solenoid seals are intact and seated correctly in their designated pockets in the manifold.	Replace seals if damaged using Eclipse Ego parts kits. Ensure seals are seated correctly.
	Damaged Eclipse Ego solenoid.	Replace Eclipse Ego solenoid.
	LPR is supercharging causing intermittent leaking.	Clean LPR Piston seal.
		Inspect regulator seal (in LPR piston) and regulator seat (in LPR body). Replace if necessary.
	Check for damaged or incorrect seals on Rammer.	Replace seals.
Is it leaking from the barbs?	Check hose for cuts or replace barbs.	

EG**TRU+Tuning
FAULT FINDING**

Symptom	Possible Cause	Solution
Eclipse Ego leaks down barrel.	Leaky Exhaust Valve.	Replace exhaust valve.
	Damaged Valve Seat.	Replace Rammer Housing.
	Incorrect seal on front of rammer housing.	Replace front seals on rammer housing with 016 seals.
Gas vents quickly down barrel as soon as gassed up.	The exhaust valve has become jammed in the brass valve guide	Replace exhaust valve and brass valve guide as necessary (see Maintenance Section).
The marker is chopping or trapping paint.	The Break Beam Sensor System is switched off.	Switch on the Break Beam Sensor System. Increase the breech open time.
	The bolt is dirty, causing the sensor system to incorrectly detect a retracted bolt.	Clean the bolt.
	The Break Beam Sensor System is dirty causing the incorrect detection of paintballs.	Clean the Break Beam Sensor System.
Eclipse Ego fires yet bolt doesn't move.	Bolt pin is not located in rammer correctly.	Lift bolt pin and line up bolt with position of rammer correctly (see Maintenance Section).

ECLIPSE 

Symptom	Possible Cause	Solution
Rear QEV leaks.	Main rammer seal is damaged.	Replace 011 seal on rammer shaft.
	Faulty seals inside QEV.	Strip QEV and inspect seals for debris or damage.
Front QEV leaks.	Faulty seals inside QEV.	Strip QEV and inspect seals for debris or damage.
Eclipse Ego does not fire.	Trigger is set up incorrectly.	Set trigger up correctly (see Advanced Set-up Section).
	Solenoid is not plugged into Eclipse Ego PCB.	Plug solenoid into port on the Eclipse Ego PCB.
	The Break Beam Sensor System is enabled but there is no paint.	Fill loader with paint.
Low Velocity First Shot	FSDO parameter is too low to overcome stiction on Solenoid and / or Rammer O-Rings.	Increase FSDO parameter.
High Velocity First Shot	FSDO parameter set too high.	Reduce FSDO parameter.
	Inline Regulator pressure creeping.	Strip and clean Inline Regulator.

Symptom	Possible Cause	Solution
My trigger is very "Bouncy", how can I reduce it?	Increase the trigger transition filter settings.	Check that your trigger pull is within the limits of your TT BAND setting and that your TT TOL suits your current set-up.
	Lengthen and strengthen your trigger pull.	Refer to the Advanced Set-up Section for guidelines of how to adjust your Ego trigger accordingly.
The Break Beam Sensor System does not appear to be reading correctly.	The Break Beam Sensor System is dirty.	Keep the break beam sensors clean to ensure correct readings (see Maintenance Section).
The Break Beam Sensor System is not reading at all.	There is a broken wire or contact, or a short circuit on either of the breech sensor ribbon cable.	Check the plug of the cable. Check for cuts or pinches in the sensor cables.
	Either sensor is back to front.	Check that sensors face each other when installed.
Two or more balls are being fed into the breech.	If the Eclipse Ego is being used with a force feed loader, it is possible that the loader is forcing balls past the ball detent.	Change the rubber finger detent.

Symptom	Possible Cause	Solution
Eclipse Ego is inconsistent.	Inline regulator is supercharging.	Strip and clean inline regulator (see Maintenance Section).
Leaking Rammer Assembly (leak gets louder when bolt is removed).	Front ram shaft seal deteriorated.	Replace front rammer shaft seal.
How can I get the best performance out of my gun?	Check your set-up.	Using a force-fed loader (Halo B, VL eVLution II) with the Break Beam Sensor System enabled will give the highest performance.
Eye turns itself off after firing.	Eye is dirty.	Clean the eyes.
	Eye is faulty.	Replace eyes.
	Eye is out of place.	Re-install Eyes. Check aignment.
When the Ego powers up, no game timer / shot counter / rof indicator is displayed and the gun will not fire.	The trigger is permanently depressed.	Turn the front stop set screw in the top of the trigger counter-clockwise until the display reads correctly. If there is insufficient trigger adjustment then turn the return force set screw counter clockwise also.

ECLIPSE®

Certified Eclipse Service Centres

Are you unsure of where to send your Eclipse Ego® to be repaired or serviced? If your local Eclipse dealer can't assist you, why not contact your nearest Certified Eclipse Service Centre and arrange to send it into them to undertake any work that you require doing.

United Kingdom & Europe

Planet Eclipse Ltd England

t: ++44 (0) 161 8725572

f: ++44 (0) 161 8725972

e: technical@planetecclipse.com

w: www.planetecclipse.com

Action Paintball Games Russia

t: ++7 (0) 95 7851762

f: ++7 (0) 95 7851738

e: info@paintball.ru

W: www.paintball.ru

OPM

Germany

t: ++49 (0) 211 2102300

f: ++49 (0) 211 21023030

e: salesforce@paintball.de

w: www.paintball.de

United States

Planet Eclipse LLC

Rhode Island,

t: 401 247 9061

f: 401 247 0931

e: ustechnical@planetecclipse.com

w: www.planetecclipse.com

59

Service Centres









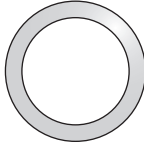

ECLIPSE®

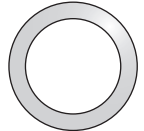
Settings Savers

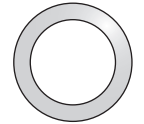
GO

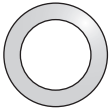
<i>Settings</i>	<i>Custom One</i>	<i>Custom Two</i>	<i>Custom Three</i>
<i>MAX ROF</i>			
<i>DWELL</i>			
<i>FSDO</i>			
<i>EMPTY</i>			
<i>BALL</i>			
<i>PULL</i>			
<i>RELEASE</i>			
<i>TT BAND</i>			
<i>TT TOL</i>			

Please use the table above to record your favourite Eclipse Ego settings.

Size Chart	Location	Size Chart	Location
016	 Rammer Housing, LPR Body, Feed Stub.	011	 Rear Rammer O-Ring.
015	 Bolt O-Ring, Inline Regulator Piston.	010	 Inside LPR body, inside Adjuster Section of Inline.
014	 Large O-Ring on top of Front Reg Mount.	009	 Rammer Front Bumper.
013	 LPR Piston.	008	 Rammer Shaft O-Ring.
012	 Adjuster Piston in LPR.	006	 Inline Adjuster Screw, OOPS.
		004	 Small O-Rings on top of Front Reg Mount.

Parts List

62

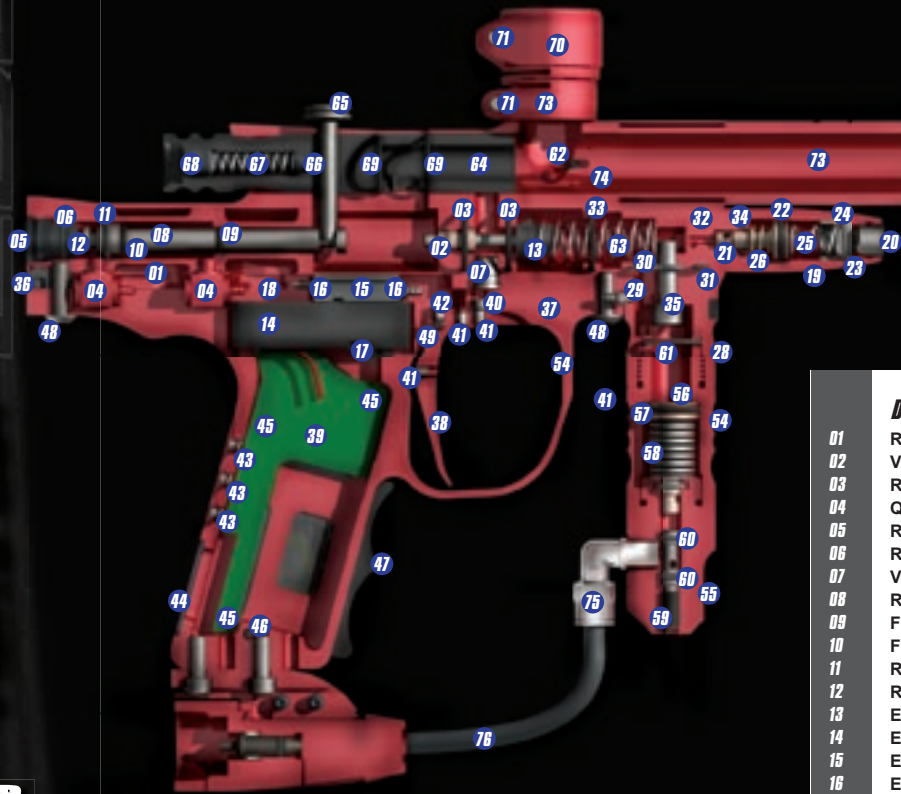

Description

Code

01	Rammer Housing	ECLIEGOSPA401
02	Valve Guide	ECLIEGOSPA402
03	Rammer Housing o-ring	ECLIEGOSPA101
04	QEV	ECLIEGOSPA601
05	Rammer Cap	ECLIEGOSPA403
06	Rammer Cap o-ring	ECLIEGOSPA106
07	Valve Plug	ECLIEGOSPA201
08	Rammer Shaft	ECLIEGOSPA404
09	Front Rammer o-ring	ECLIEGOSPA109
10	Front Rammer Bumper o-ring	ECLIEGOSPA108
11	Rear Rammer o-ring	ECLIEGOSPA106
12	Rear Rammer Bumper	ECLIEGOSPA113
13	Exhaust Valve Assembly	ECLIEGOSPA602
14	Ego Solenoid	ECLIEGOSPA501
15	Ego Minifold	ECLIEGOSPA405
16	Ego Minifold Barb	ECLIEGOSPA701

	<i>Description</i>	<i>Code</i>
17	Ego Solenoid Retaining Screw	ECLIEGOSPA202
18	Ego Low Pressure Hose	ECLIEGOSPA702
19	LPR Cap	ECLIEGOSPA406
20	LPR Adjuster Screw	ECLIEGOSPA203
21	LPR Piston	ECLIEGOSPA407
22	LPR Piston o-ring	ECLIEGOSPA105
23	Adjuster Piston	ECLIEGOSPA408
24	Adjuster Piston o-ring	ECLIEGOSPA107
25	LPR Spring Heavy (Gold)	ECLIEGOSPA301
26	LPR Spring Light (Silver)	ECLIEGOSPA302
27	9 Volt Battery	ECLIEGOSPA303
28	Front Regulator Mount	ECLIEGOSPA409
29	FRM Barb	ECLIEGOSPA701
30	FRM Main Seal	ECLIEGOSPA104
31	LPR Inlet/Outlet Seal	ECLIEGOSPA111
32	LPR Body	ECLIEGOSPA410
33	LPR Body o-ring	ECLIEGOSPA101
34	LPR Body groove o-ring	ECLIEGOSPA107
35	FRM screw	ECLIEGOSPA203
36	Frame Tag	ECLIEGOSPA411
37	Ego Frame	ECLIEGOSPA412
38	Ego Trigger	ECLIEGOSPA413
39	Ego Printed Circuit Board	ECLIEGOSPA502
40	Magnet	ECLIEGOSPA604
41	Ego Trigger Adjuster Screw	ECLIEGOSPA204
42	Ego Trigger Pin Locking screw	ECLIEGOSPA205
43	Push Button	ECLIEGOSPA605
44	Display Window	ECLIEGOSPA606
45	Ego PCB Screw	ECLIEGOSPA206
46	Ego Grip Screw	ECLIEGOSPA207
47	Ego Grips	ECLIEGOSPA607
48	Ego Frame Screw	ECLIEGOSPA211
49	Ego Trigger Pin	ECLIEGOSPA614

	<i>Description</i>	<i>Code</i>
50	Ego Sensor Cover (left)	ECLIEGOSPA414
51	Ego Sensor Cover (right)	ECLIEGOSPA415
52	Ego Cover Screw	ECLIEGOSPA207
53	Ego Break Beam Sensor System	ECLIEGOSPA503
54	Inline Regulator Top	ECLIEGOSPA416
55	Inline Regulator Bottom	ECLIEGOSPA417
56	Inline Regulator Piston	ECLIEGOSPA418
57	Inline Regulator Piston o-ring	ECLIEGOSPA102
58	Inline Regulator Belleville Spring	ECLIEGOSPA304
59	Inline Regulator Adjuster	ECLIEGOSPA419
60	Inline Regulator Adjuster o-ring	ECLIEGOSPA110
61	Inline Regulator Top o-ring	ECLIEGOSPA103
62	Anti Double Ball Finger	ECLIEGOSPA608
63	Ego Valve Spring	ECLIEGOSPA305
64	Ego Bolt	ECLIEGOSPA609
65	Ego Bolt Pin	ECLIEGOSPA610
66	Ego Bolt Plunger	ECLIEGOSPA611
67	Ego Bolt Plunger Spring	ECLIEGOSPA306
68	Ego Bolt Spring Retaining Screw	ECLIEGOSPA208
69	Ego Bolt o-ring	ECLIEGOSPA102
70	Ego Clamping Feed Tube	ECLIEGOSPA420
71	Ego Clamping Feed Tube Screw	ECLIEGOSPA209
72	Ego Clamping Feed Tube o-ring	ECLIEGOSPA102
73	Ego Shaft Solo Barrel	ECLIEGOSPA421
74	Ego 05 Body	ECLIEGOSPA422
75	1/4" Elbow	ECLIEGOSPA703
76	1/4" Hose	ECLIEGOSPA704

	<i>Parts Kits</i>	<i>Code</i>
77	Ego Comprehensive Parts Kit	ECLIEGOACC001
78	Ego Break Beam Sensor System Kit	ECLIEGOACC002
79	Ego Exhaust Valve Kit	ECLIEGOACC003
80	Ego Hardware Kit	ECLIEGOACC004
81	Ego Detent Kit	ECLIEGOACC005
82	Ego Contrast Colour Upgrade Kit	ECLIEGOACC006

63

Parts List

ALARM

ALARM refers to adjusting the Alarm Timer in the TIMER Menu.

BALL

BALL refers to the Ball detection time, a feature of the Filter section of the Set-up Menu.

Barrel Condom

A safety device, that when used properly restricts paintballs from leaving the end of the barrel, when fired unintentionally.

BBSS

An abbreviation for the Break Beam Sensor System.

Chronograph

A device that is used to measure the speed of the paintballs being fired from your Eclipse Ego.

Detent

A device to prevent more than one paintball being loaded into the breech. In Egos case dual rubber finger detents.

Dwell

The amount of time that the exhaust valve is held open by the rammer.

Eclipse

The custom house and now manufacturers of the Eclipse Ego.

Ego

The first Eclipse Genuine Original marker.

EMPTY

EMPTY refers to the Empty Breech detection time, a feature of the Filter section of the Set-up Menu.

FACTORY

FACTORY refers to the Factory Settings Menu in the Set-up Menu

Frame Tag

A small rectangular component that slides underneath the rammer assembly allowing the rear frame screw to be attached.

FRM

The Front Regulator Mount (FRM) allows the inline regulator to be connected to the Eclipse Ego and splits the air supply between the valve and the LPR.

FSDO

FSDO refers to First Shot Drop Off, a feature of the Timing section of the Set-up Menu.

GAME

GAME refers to adjusting the Game Timer in the TIMER Menu.

INFO

Refers to the Information Menu.

Inline Regulator

The inline regulator regulates the gas flow from your air system into the Eclipse Ego. The Inline regulator setting also determines the velocity of your Eclipse Ego.

LCD

The Liquid Crystal Display that is on the rear of the Eclipse Ego grip frame.

LPR

The Low Pressure Regulator (LPR) controls the amount of air directed via the solenoid to the rammer.

Lube Tube

The tube of Eclipse Ego lube that comes with the marker.

MAX ROF

MAX ROF refers to the Maximum Rate of Fire setting, a feature of the Timing section of the Set-up Menu.

PCB

An abbreviation for the Printed Circuit Board.

PULL

PULL refers to the Trigger Pull time in the Filter Menu.

Rammer

A combination ram and hammer assembly utilised in the Eclipse Ego.

RELEASE

RELEASE refers to the Trigger Release time in the Filter Menu.

ROF

ROF refers to the Rate of Fire display, a feature of the Main Menu.

SEMI

SEMI refers to Semi-automatic mode in the Mode Menu.

Shaft Solo

14" one-piece barrel that is included with the Eclipse Ego.

SHOTS

SHOTS refers to the Shot Counter, a feature of the Main Menu.

Solenoid

The solenoid controls the air supply to either side of the rammer.

START

START refers to choosing your preferred Game Timer start method in the TIMER Menu.

T SHOTS

T SHOTS refers to the total number of shots that you have fired from your Eclipse Ego.

TIMER

TIMER refers to the Game Timer Menu, a feature of the Main Menu. It also applies to viewing the Game Timer when using the DISPLAY Menu.

TT BAND

TT BAND refers to the Trigger Transition Band setting in the Filter Menu.

TT TOL

TT TOL refers to the Trigger Transition Tolerance setting in the Filter Menu.

Velocity

The speed at which a paintball is fired from your Eclipse Ego.

VERSION

VERSION refers to the firmware version that you have installed in your Eclipse Ego.



81

Detent Spares Kit

Kit contains 10 Rubber Detents.



80

Hardware Spares Kit

Kit contains all required Ego screws.

Contrast Colour Upgrade Kit

Allows you to swap and customize the look of your Ego marker by replacing these key components. Various colours available.



82

Exhaust Valves Spares Kit

Kit contains 2 exhaust valves, 1 brass bush and replacement O-Rings for Rammer Housing.



79



78

RBSS Spares Kit

Kit contains Break Beam Sensor System, detents and Sensor Cover retaining screws.



77

Comprehensive Spares Kit

Kit features a combination of all the spares kits currently available.



ECLIPSE @

Eclipse, Planeteclipse, Ego, the Ego logo, Inspire Create Destroy and the Eclipse grip design are all design trademarks, trademarks or registered trademarks of Planet Eclipse Ltd.
Licensed under one or more of the following patents: **US** 6311682, 6615814, 5881707, 5967133, 6035843, 6474326B1, 6637421B2 **UK** GB 234270, GB 2345953